

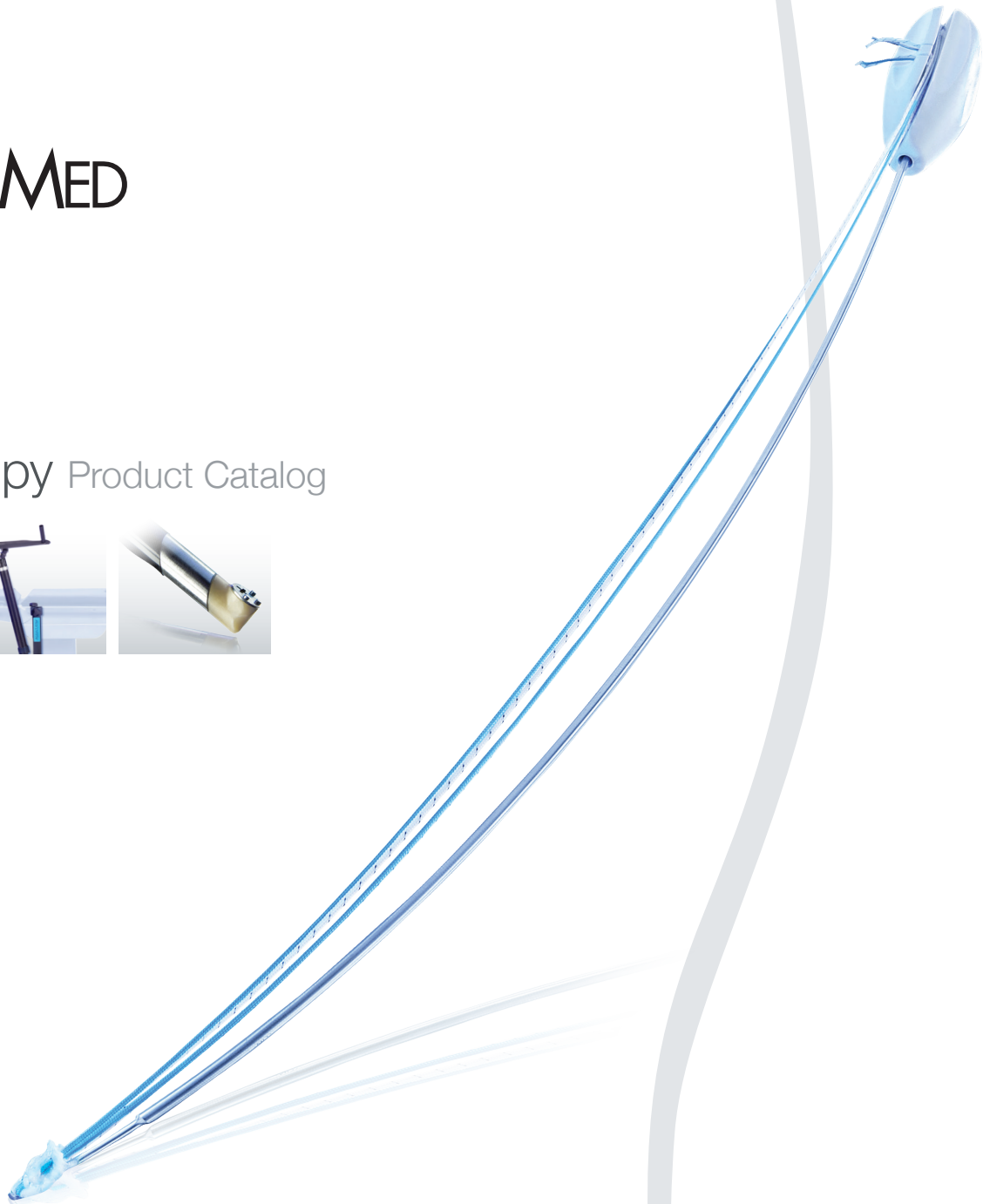

Arthroscopy Product Catalog



POPLOK[®]
ANCHOR



SHAVER
BLADES



24K[®]
PUMP



IM8000
CAMERA SYSTEM



Ordering Information	2	Small Joint Probes, Curettes and Dissectors	
Product Support.....	3	Shutt Line Of Instruments	82
Product Support and Service Programs.....	4	Small Joint Arthroscopy Knives/Tubing and Cannula Set.....	83
Return/Repair Information.....	5	Carpal Tunnel Release Kit.....	84
Shoulder Arthroscopy Products.....	6	Extremity Traction Device	85
Rotator Cuff Repair	7-15	Anchors	86-87
Instability Repair	16-20	Small Joint Electrodes.....	88
Biceps Tenodesis.....	21	Fracture Fixation Products	89
Suture Passing	22-24	1.5mm Bone Fixation Kit Self-Reinforced 96L/4D PLA Implant.....	90
Master Arthroscopy Shoulder Set	25	SmartPin® Self-Reinforced PLLA Implants	91
Tissue Repair.....	26	Arthroscopy Manual Instruments	92
Tissue Repair Accessories.....	27	Shutt Manual Instruments	93
Hi-Fi® Suture.....	28	Shutt.....	94-98
Cannula Systems.....	29-31	Shutt Suction Punch Forceps and Suction Graspers.....	99
Positioning Devices.....	32	Shutt Instrument Sets	100
Arthroscopic Accessories	33	Concept®	101-106
Knee Arthroscopy Products	34	MASTER Arthroscopy Shoulder Instrument Set.....	107
Biocomposite Interference Screws.....	35	Shutt Small Joint	108-109
Bioabsorbable Interference Screws.....	36-38	Accessories.....	110-111
Metal Interference Screws.....	39-42	Resection Products	112
Femoral Fixation Implants	43-46	Consoles and Footswitches	113
Graft Tensioning System.....	47	Accessories.....	114
Cruciate Reconstruction System.....	48, 49	Handpieces	115
Cruciate Reconstruction Accessories	50-55	Hip Blades and Burs	116-117
Graft Preparation System	56	Large Hub Shaver Blades.....	118-122
Sawblades Accessories.....	57	Large Hub Burs and Routers	123-125
Reamer Systems	58-61	Micro Hub Blades	126-128
OCD Repair	62	Micro Hub Burs and Routers	129
Meniscal Fixation Implants	63	Fluid Management Products	130
Meniscal Fixation Systems	64-66	24k® Pump System	131-132
Sterilization Trays.....	67	10k® Fluid System	133
Positioning Devices.....	68	87k® Fluid Control System Accessories.....	134
Hip Arthroscopy Products	69	Apex® Universal Irrigation Accessories.....	135
Bridge System.....	70	Irrigation Console Accessories.....	136
Hip Access	71	Gravity Tubing.....	137
Shutt® Series 210® Manual Instruments	72	Suction Devices.....	138
Hip Blades and Burs.....	73	ESA Electrosurgical Arthroscopy Products.....	139
Hip Manual Instruments	74	Edge Bi-Polar Arthroscopic RF System.....	140
Hip Suture Passers	75	LightWave® Ablators.....	141
Anchors	76	UltrAblator® Electrosurgical.....	142
Suction Ablator and Tray	77	Concept® Ablator Electrodes and Kits.....	143
Small Joint Arthroscopy Products.....	78	ESA Electrosurgical Arthroscopy Electrodes.....	144-145
Small Joint Forceps and Graspers		Endoscopic Systems	146
Shutt Line Of Manual Instruments	79-80	Autoclavable Small Joint Arthroscopes and Sheath Systems.....	147
Small Joint Instrument Sets and Case		Autoclavable Arthroscopes and Sheath Systems	148-152
For Shutt Line Of Manual Instruments	81	Sterilization Trays.....	153

Terms

CONMED standard terms are net thirty (30) days, F.O.B. shipping point, unless otherwise approved in writing by CONMED. All orders and transactions are subject to the laws of the state of Florida.

To Place Your Order

Please provide a purchase order number, billing and shipping instructions, product catalog number and description, valid CONMED quotation, and quantity and pricing to one of the following:

Your Sales Representative

Customer Service

Phone: 800-237-0169

Fax: 727-399-5256

E-mail: custserv1@com

CONMED

Attn: Customer Service

11311 Concept Boulevard

Largo, FL 33773-4908 USA

True Purchasing Flexibility

CONMED Financial Services offers a variety of flexible financing programs, from leases to Pre-Procedure Programs to delayed payment plans. Ask your Sales Representative for more information on how you can acquire the latest technology through a financing program that fits your unique budgetary requirements.

Rental Program for Instrument Sets and Capital Equipment

In every O.R., there are times when you have to schedule a case but do not have the equipment needed. Either the capital funding for the equipment has yet to be approved or you have been unable to justify the cost of the equipment due to the procedure's low volume.

For these situations, CONMED offers a rental program for procedure-specific instruments and capital equipment. Simply call CONMED at 888-587-9742 and everything that you need for the case is on its way.

To enroll in a rental program, contact your Sales Representative or call the CONMED field inventory team. Your representative will help you customize the kit(s) to fit your procedural requirements. After the case, simply return the instruments, cleaned and sterilized if appropriate, along with any disposables you did not use. The rental fee will be billed for the disposables not returned, and customer will be responsible for any expedited shipping cost.

Failure to return instrumentation/equipment at the end of the rental period will result in the customer being charged the standard rental fee automatically for each week that the instrumentation/equipment is not received by CONMED.

At CONMED, we want to offer more than a quality product. We take pride in being able to provide you with value added services to support our products. The information given in this catalog is designed to address your questions regarding product support.

Customer Support

If you encounter a problem or need technical assistance, contact Customer Service (Product Support) or your Sales Representative. Refer to the Customer Service telephone numbers listed.

Regulatory Compliance

Report any injuries or malfunctions to CONMED Customer Service. Refer to the Customer Service telephone numbers listed.

Original Warranty

CONMED (the "Company") warrants to the first purchaser or lessee ("You" or "Customer") that the instruments, attachments and parts manufactured by or for the Company (hereinafter collectively "Instruments") have been tested, inspected, and shipped in proper working order.

The Company warrants all new instruments to be free from defects in materials and workmanship for the following periods, measured from date of sale:

Product Categories	Months
All Single Use Products.....	Upon Receipt
MPower® and MPower 2 Handpieces	24
Powered Surgical Instruments.....	12
Power Attachments and Accessories	12
Handpiece Cords and Power Cords	6
Pneumatic Hoses.....	6
Bur Guards, Blade Guards, Attachments	6
Battery Packs and Accessories.....	3
Battery Chargers	12
Camera Consoles	12
Video Components	12
Video Cables and Light Guides.....	3
Scopes.....	12
Camera Heads	12
Instruments	12
Instrument Tray.....	3
Footswitches	12
Irrigation Systems (Pumps and Remotes).....	12
Reusable Procedure Specific Instruments	6

Following the Original Warranty, CONMED offers additional warranty and service programs that support our products throughout their lifetime. Service programs address the necessity to control cost and greatly reduce repair turnaround time by eliminating the need for repair quotes.

Products not covered under a service program are subject to variable repair charges. To find out which service option best meets your needs, contact your local Sales Representative.

Service Agreements

Service Agreements provide additional service coverage on capital equipment. This additional warranty period covers all repair costs, periodic maintenance, free loaner usage during repair time and freight charges out from CONMED both on the loaner product and the repaired instrument.

Service Warranty

After expiration of the Original or Service Agreement period, instruments may be returned to CONMED for repair at the customer's expense. CONMED warrants that any service or repair work performed by CONMED shall be free from defects in workmanship and materials for a period of 90 days after the date the customer receives the Instrument(s). This limited warranty applies only to the actual service or repair work performed by CONMED or its authorized service centers. CONMED warrants that all parts and assemblies used in the repair or service of Instruments meet new part functional specifications, although some parts or assemblies may have been remanufactured.

CONMED components are manufactured to exacting tolerances and design specifications. As a standard practice, all repairs are subject to strict product performance and testing specifications prior to returning the Instrument to the customer. CONMED ensures that each Instrument is inspected according to the guidelines used for new manufactured Instruments. If an Instrument is determined unrepairable, CONMED will offer to sell to the customer a refurbished or brand new Instrument or comparable equivalent at a preferential price. All parts and assemblies replaced by CONMED shall become the property of CONMED.

Repair Quotes

Upon request Customer Service can estimate the repair charges for non-warranty repairs. If a firm repair quote is requested, please return your product for inspection and you will be contacted before the repair is initiated. If a product is returned and a firm quote is not requested, the repair will be processed and your account billed accordingly.

Minimum Service Charge

There is a minimum repair charge for the evaluation and testing of all returns (except for products covered under warranty).

Return Shipping

All repaired products will be returned to you via second day air delivery unless you request an alternate shipping method. The cost of return shipping is your responsibility unless the product is under warranty or service agreement.

Warranty Terms

If the customer discovers within the warranty period (Original or Service Agreement) that an Instrument has a defect in materials and/or workmanship, the customer must promptly notify the Company. Also, if the customer discovers within the service warranty period that any service or repair work performed by CONMED has a defect in workmanship and/or materials, the customer must promptly notify the Company. If it becomes necessary to return the Instrument to the Company, the customer must (a) acquire a "Service Request" (SR) authorization from the Company Customer Service Department, (b) pack the unit carefully, and (c) return it to the Company.

Within a reasonable time after receipt of the Instrument, the Company will investigate and correct any defect covered by warranty by providing, at its option, one of the following: service or repair of the Instrument, or replacement of the Instrument. All parts and assemblies replaced by CONMED shall become the property of CONMED. These remedies are the customer's exclusive remedies under the warranty.

The foregoing limited warranties do not apply to:

- » Instruments that have been tampered with, altered, neglected, or misused,
- » Instruments damaged through use with other than Company authorized accessories, attachments, burs or blades,
- » Instruments not manufactured by or for the Company,
- » Instruments used for purposes other than those for which they were designed and manufactured, including use in any way inconsistent with the instructions and warnings contained in the Company instruction manuals and package inserts, and
- » Instruments that were last serviced, refurbished, reprocessed or reconditioned by a nonauthorized service entity.

THE FOREGOING LIMITED WARRANTIES ARE IN LIEU OF ALL OTHER WARRANTIES, EXPRESS OR IMPLIED, INCLUDING, BUT NOT LIMITED TO, THE IMPLIED WARRANTIES OF MERCHANTABILITY AND FITNESS FOR A PARTICULAR PURPOSE.

In no case shall the Company be liable for any special, incidental, indirect or consequential damages based upon breach of warranty or any other legal theory. Some jurisdictions do not allow limits on warranties, or on remedies, and, in such jurisdictions, the limits in this and the preceding paragraphs may not apply.

The Company reserves the right (a) to make design changes to Instruments at any time without notice to customer and without incurring any obligation to incorporate those changes into Instruments previously purchased or leased, and (b) to make changes from time to time in the contents of any publication, instruction manual or package insert without any obligation to notify customers of such revisions or changes, and (c) to change price without notice.

U.S. Procedure for Returns/Repairs

1. All Instruments must be cleaned and sterilized, if appropriate, prior to return of any Instrument to CONMED. Instruments contaminated with biohazardous materials will be returned to you at your expense.
2. An authorized Service Request (SR) Number must be obtained prior to returning any Instrument for repair/return.
3. To return a product for repair, contact CONMED Customer Service. The following information is needed to process a repair/return:
 - » Catalog Number
 - » Serial/Lot Number
 - » Original Invoice Number
 - » Detailed description of the problem or reason for return
4. The SR number must be displayed on the outside of the box, included with all paperwork, and must be referred to when making an inquiry about the status of a repair/return.
5. CONMED maintains various repair centers around the world. When you are issued your SR number, you will be advised of the location where to send your product.

Return Terms

If it becomes necessary to return a product after purchase, the product must be returned within 45 days of its ship date. The product must be returned unused, in the original packaging and be restockable. Returns must be shipped prepaid freight. Returns that are not shipped prepaid freight will not be accepted. All product returns, except those attributable to a CONMED error, are subject to a restocking fee of 15% of the purchase price or \$25, whichever is greater.

Products Not Eligible for Credit:

- » Sterile products/single use devices returned with the outer packaging seals broken
- » Non-sterile products that have been sterilized and/or placed in the surgical field
- » Products damaged by customer misuse or negligence
- » Altered or customized products
- » Products damaged in return transit due to inadequate packaging
- » Less than full packages – all products must be in original packaging
- » Obsolete products

Packaging

Whenever it is required to return your product, be sure to package it in a protective carton. We recommend that you save the original shipping container for this purpose. In-transit damage is not covered by the warranty; therefore, it is best to always insure shipments.

SHOULDER ARTHROSCOPY PRODUCTS

All products may not be available in all markets.

Y-Knot® RC All-Suture Anchor

The only self-punching all suture anchor

- » Self-Punching = Simpler Technique
- » 360° FormFit™ Fixation = Strong Purchase (575N pullout)
- » Small Size = Less Bone Removal (2.8mm footprint, expands subcortically to 5.0mm)
- » All-Suture = Less Invasive
- » Available double- or triple-loaded

Implants

	Cat. No.
Y-Knot® RC All-Suture Anchor w/two #2 Hi-Fi® sutures	YRC02
Y-Knot RC All-Suture Anchor w/three #2 Hi-Fi sutures.....	YRC03

Instruments (for Hard Bone)

2.8mm Y-Knot RC Disposable Broaching Punch.....	Y-DBP28
2.8mm Y-Knot RC Reusable Broaching Punch	Y-BP28
2.8mm Y-Knot RC Disposable Drill Bit	Y28D
Y-Knot RC Drill Guide	Y-DGRC
Y-Knot RC Drill Guide Obturator.....	Y-OBRC



Y-Knot® RC triple-loaded anchor



2.8mm Y-Knot RC Broaching Punch



2.8mm Y-Knot RC Drill Bit

All products may not be available in all markets.



6.5mm CrossFT™ Suture Anchor



6.5mm CrossFT Broaching Punch



6.5mm CrossFT Tap

CrossFT™ Suture Anchor

- All PEEK fully threaded anchor
- » For medial row or primary fixation
- » Cancellous and cortical threads provide exceptional fixation strength
- » Broaching punch minimizes cortical stress fractures
- » Cannulated to channel growth factors
- » Double or triple loaded with Hi-Fi® Suture

Implants	Suture Color White, white-blue, white- black, and/or white-green	Suture Color Blue, white-blue, and/or white-black
4.5mm CrossFT™ Suture Anchor w/Two #2 Hi-Fi Sutures (17mm length)	CFP-4502	CFP-4502B
4.5mm CrossFT Suture Anchor w/Two #2 Hi-Fi Sutures (17mm length) w/needles	CFP-4502N	CFP-4502NB
4.5mm CrossFT Suture Anchor w/Three #2 Hi-Fi Sutures (17mm length)	CFP-4503	CFP-4503B
4.5mm CrossFT Suture Anchor w/Three #2 Hi-Fi Sutures (17mm length) w/needles	CFP-4503N	CFP-4503NB
5.5mm CrossFT Suture Anchor w/Two #2 Hi-Fi Sutures (17mm length)	CFP-5502	CFP-5502B
5.5mm CrossFT Suture Anchor w/Two #2 Hi-Fi Sutures (17mm length) w/needles	CFP-5502N	CFP-5502NB
5.5mm CrossFT Suture Anchor w/Three #2 Hi-Fi Sutures (17mm length)	CFP-5503	CFP-5503B
5.5mm CrossFT Suture Anchor w/Three #2 Hi-Fi Sutures (17mm length) w/needles	CFP-5503N	CFP-5503NB
6.5mm CrossFT Suture Anchor w/Two #2 Hi-Fi Sutures (17mm length)	CFP-6502	CFP-6502B
6.5mm CrossFT Suture Anchor w/Two #2 Hi-Fi Sutures (17mm length) w/needles	CFP-6502N	CFP-6502NB
6.5mm CrossFT Suture Anchor w/Three #2 Hi-Fi Sutures (17mm length)	CFP-6503	CFP-6503B
6.5mm CrossFT Suture Anchor w/Three #2 Hi-Fi Sutures (17mm length) w/needles	CFP-6503N	CFP-6503NB

Instruments

Universal CrossFT Broaching Punch	PFT-00M
4.5mm CrossFT Broaching Punch	PFT-45M
5.5mm CrossFT Broaching Punch	PFT-55M
6.5mm CrossFT Broaching Punch	PFT-65M
4.5mm CrossFT Tap	TFT-45M
5.5mm CrossFT Tap	TFT-55M
6.5mm CrossFT Tap	TFT-65M



CrossFT™ and PopLok® are comprised of PEEK-OPTIMA® polymer from Invibio® Biomaterial Solutions. PEEK-OPTIMA and INVIBIO are registered trademarks of Invibio Ltd. All Rights are Reserved.

All products may not be available in all markets.

GENESYS™ CrossFT™ Suture Anchor

Biocomposite, fully-threaded anchor.

- » Composed of GENESYS™ biocomposite material, using microTCP technology
- » For medial row or primary fixation
- » Cancellous and cortical threads provide exceptional fixation strength
- » Broaching punch minimizes cortical stress fractures
- » Cannulated to channel growth factors
- » Double or triple loaded with Hi-Fi® Suture

Implants

	Suture Color	Suture Color
	White, white-blue, white-black, and/or white-green	Blue, white-blue, and/or white-black
4.5mm GENESYS™ CrossFT™ Suture Anchor w/Two #2 Hi-Fi Sutures (17mm length)	CFBC-4502	CFBC-4502B
4.5mm GENESYS CrossFT Suture Anchor w/Two #2 Hi-Fi Sutures (17mm length) w/needles.....	CFBC-4502N.....	CFBC-4502NB
4.5mm GENESYS CrossFT Suture Anchor w/Three #2 Hi-Fi Sutures (17mm length)	CFBC-4503	CFBC-4503B
4.5mm GENESYS CrossFT Suture Anchor w/Three #2 Hi-Fi Sutures (17mm length) w/ needles.....	CFBC-4503N.....	CFBC-4503NB
5.5mm GENESYS CrossFT Suture Anchor w/Two #2 Hi-Fi Sutures (17mm length)	CFBC-5502	CFBC-5502B
5.5mm GENESYS CrossFT Suture Anchor w/Two #2 Hi-Fi Sutures (17mm length) w/needles.....	CFBC-5502N.....	CFBC-5502NB
5.5mm GENESYS CrossFT Suture Anchor w/Three #2 Hi-Fi Sutures (17mm length)	CFBC-5503	CFBC-5503B
5.5mm GENESYS CrossFT Suture Anchor w/Three #2 Hi-Fi Sutures (17mm length) w/needles.....	CFBC-5503N.....	CFBC-5503NB
6.5mm GENESYS CrossFT Suture Anchor w/Two #2 Hi-Fi Sutures (17mm length)	CFBC-6502.....	CFBC-6502B
6.5mm GENESYS CrossFT Suture Anchor w/Two #2 Hi-Fi Sutures (17mm length) w/needles.....	CFBC-6502N.....	CFBC-6502NB
6.5mm GENESYS CrossFT Suture Anchor w/Three #2 Hi-Fi Sutures (17mm length)	CFBC-6503.....	CFBC-6503B
6.5mm GENESYS CrossFT Suture Anchor w/Three #2 Hi-Fi Sutures (17mm length) w/needles.....	CFBC-6503N.....	CFBC-6503NB

GENESYS CrossFT Instruments

4.5mm GENESYS CrossFT Broaching Punch	PFT-45MB
5.5mm GENESYS CrossFT Broaching Punch	PFT-55MB
6.5mm GENESYS CrossFT Broaching Punch	PFT-65MB
4.5mm GENESYS CrossFT Punch/Tap	TFT-45MB
5.5mm GENESYS CrossFT Punch/Tap	TFT-55MB
6.5mm GENESYS CrossFT Punch/Tap	TFT-65MB



5.5mm GENESYS™ CrossFT™ Suture Anchor



5.5mm GENESYS™ CrossFT™ Broaching Punch



5.5mm GENESYS™ CrossFT™ Punch/Tap

All products may not be available in all markets.

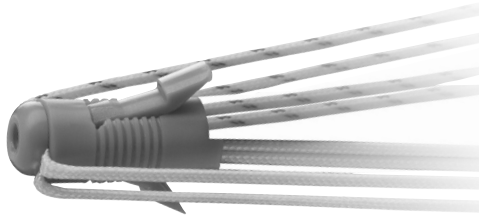

4.5mm PopLok® Suture Anchor

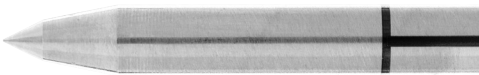

4.5mm PopLok Punch



Super Revo® FT and ThRevo® FT Suture Anchor



Shoulder Restoration System – Instrument Tray

PopLok® Suture Anchor

All PEEK knotless anchor

- » For lateral row or primary fixation
- » Provides ability to tension sutures individually and separately from anchor seating
- » Suture locks within the anchor
- » Sub-cortical wings provide fixation
- » Tactile and audible “POP” confirms fixation

Cat. No.

Implants

3.5mm PopLok® Suture Anchor (11mm length, Deployed)	CKP-3500
3.5mm PopLok Suture Anchor w/One #2 Hi-Fi® Suture (11mm length, Deployed)	CKP-3501
4.5mm PopLok Suture Anchor (11mm length, Deployed)	CKP-4500
4.5mm PopLok Suture Anchor w/Two #2 Hi-Fi Sutures (11mm length, Deployed)	CKP-4502

Instruments

3.5mm PopLok Punch.....	PKL-35M
4.5mm PopLok Punch.....	PKL-45M

Super Revo® FT and ThRevo® FT Suture Anchors

Titanium, self-punching fully threaded anchor

- » Proven Revo® Technology
- » Double or Triple loaded w/#2 Hi-Fi® Suture

Implants

Sutures: White, white-blue, white-black, and/or white-green **Sutures:** blue, white-blue, and/or white-black

Super Revo® FT Suture Anchor, 5.0mm O.D. 18.0mm length, w/Two #2 Hi-Fi Sutures	CF6140H.....	CF6140HB
Super Revo FT Suture Anchor, 5.0mm O.D. 18.0mm length, w/Two #2 Hi-Fi Sutures, w/needles	CF6140HN.....	CF6140HNB
ThRevo® FT Suture Anchor, 5.0mm O.D. 18.0mm length, w/Three #2 Hi-Fi Sutures,.....	CF6160H.....	CF6160HB
ThRevo FT Suture Anchor, 5.0mm O.D. 18.0mm length, w/Three #2 Hi-Fi Sutures, w/needles	CF6160HN.....	CF6160HNB

SRS Instrument Tray

Shoulder Restoration System – Instrument Tray.....	RCR-TRAY
--	----------



CrossFT™ and PopLok® are comprised of PEEK-OPTIMA® polymer from Invibio® Biomaterial Solutions. PEEK-OPTIMA and INVIBIO are registered trademarks of Invibio Ltd. All Rights are Reserved.

All products may not be available in all markets.

Super Revo® and ThRevo® Suture Anchors

Titanium, self-punching anchor

- » Self-drilling cutting tip does not require a pilot hole
- » Independent Suture Sliding (I.S.S.™) Eyelet enables suture to slide freely during suture passing and knot tying
- » Available pre-loaded on a sterile, disposable driver

Implants

Cat. No.

Super Revo® Suture Anchor, w/Blue suture, 5.0mm O.D. x 14mm length, on a Disposable Driver (w/Two #2 Hi-Fi Sutures)	C6140HB
Super Revo Suture Anchor, 5.0mm O.D. x 14mm length, Pre-Loaded with Disposable Driver w/Two #2 Polyester Sutures	C6140
Super Revo Suture Anchor, 5.0mm O.D. x 14mm length, Anchor & Suture Only w/Two #2 Polyester Sutures, Pre-Threaded	C6141
Super Revo Suture Anchor, 5.0mm O.D. x 14mm length, Pre-Loaded with Disposable Driver w/Two #2 Hi-Fi Sutures	C6140H
ThRevo® Suture Anchor w/ Blue suture, 5.0mm O.D. x 14mm length, a Disposable Driver (w/Three #2 Hi-Fi Sutures)	C6160HB
ThRevo Suture Anchor, 5.0mm O.D. x 14mm length, Pre-Loaded with Disposable Driver w/Three #2 Hi-Fi Sutures	C6160H
ThRevo Suture Anchor, 5.0mm O.D. x 14mm length, Anchor & Suture Only w/Three #2 Hi-Fi Sutures, Pre-Threaded.....	C6161H

Instruments

Suture Threader	C6113
Loop Handle Knot Pusher	C6112
Crochet Hook	C6105
Low Profile, Slotted Jaw, Suture Punch, 4mm Needle	18.1008
Low Profile, Slotted Jaw, Suture Punch, 7mm Needle	18.100124
Super Revo® & ThRevo® Driver	C6142
Super Revo & ThRevo Removal Guide	C6143
Basic Instrument Tray with Lid (for Super Revo or Revo)	C6108

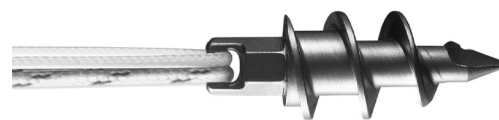

Super Revo®

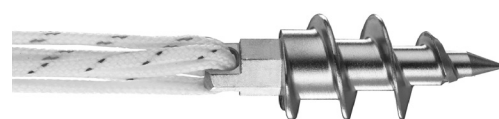

ThRevo®

All products may not be available in all markets.

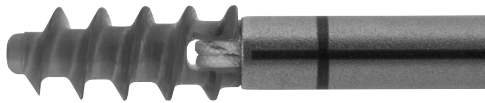

Paladin® Suture Anchor



Paladin Tap



Duet™ Suture Anchor



Duet Tap

Paladin® Suture Anchor

- Bioabsorbable twist-in anchor
- » Self-Reinforced 96L/4D PLA
 - » Innovative thread lead in design allowing for easy tap engagement

Cat. No.

Implants

- Paladin Suture Anchor, 5.0mm O.D. x 15.3mm length,
w/Two #2 Hi-Fi® Sutures C5070H
- Paladin Suture Anchor, 6.5mm O.D. x 16.3mm length,
w/Two #2 Hi-Fi Sutures C6570H

Instruments

- 5.0mm Paladin Tap C5075

Duet™ Suture Anchor

- Bioabsorbable twist-in anchor
- » Self-Reinforced 96L/4D PLA
 - » Two individual eyelets for independent suture manipulation
 - » Includes a 3.5mm disposable Bone Punch
 - » Pre-threaded w/two strands of #2 polyester suture or #2 Hi-Fi Suture
 - » Pre-threaded with needles

Implants

- Duet Suture Anchor, 6.0mm O.D. x 16.5mm length,
w/Two #2 Polyester Sutures (includes 3.5mm Disposable Bone Punch)..... BXS4216
- Duet Suture Anchor, 6.0mm O.D. x 16.5mm length,
w/Two #2 Hi-Fi Sutures (includes 3.5mm Disposable Bone Punch) BXS4216H

Instruments

- Duet Reusable Tap, 5.9mm dia., Tear Drop HandleBT1007
- Duet Disposable Tap.....BT1004

All products may not be available in all markets.

Revo® Suture Anchor

- Titanium twist-in anchor
- » 4mm wide cancellous threads
- » Pre-loaded w/one #2 polyester or Hi-Fi® Suture

Implants

	Cat. No.
Revo Suture Anchor, 4.0mm O.D. x 12mm length, Anchor & Suture Only (w/One #2 Polyester Suture, Pre-Threaded)	C6101A
Revo Suture Anchor, 4.0mm O.D. x 12mm length, Anchor & Suture Only (w/One #2 Hi-Fi Suture, Pre-Threaded)	C6101H

Instruments

Revo Driver	C6102B
Suture Threader	C6113
Revo Drill Bit, 2mm dia	C6106A
Revo Bone Punch, 2mm dia	C6107
Revo Remover Guide	C6126
Loop Handle Knot Pusher.....	C6112
Crochet Hook	C6105
Low Profile, Slotted Jaw, Suture Punch, 4mm Needle	18.1008
Low Profile, Slotted Jaw, Suture Punch, 7mm Needle	18.100124
Basic Instrument Tray with Lid (Super Revo or Revo).....	C6108
Master Instrument Tray with Lid (Super Revo or Revo)	C6202



Revo® Suture Anchor

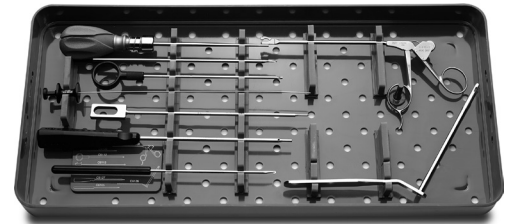

Master Instrument Tray

All products may not be available in all markets.

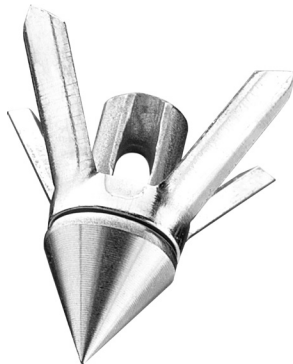

UltraFix RC® Suture Anchor

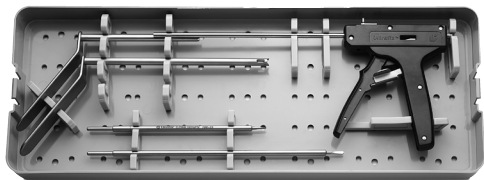

UltraFix Sterilization Tray

Ultrafix RC® Suture Anchor

Titanium, deployable suture anchor

- » Removal and repositioning possible prior to final placement
- » Low-profile suture eyelet never projects above bone surface
- » Enlarged suture eyelet with rounded, polished edges protects suture from breakage
- » Accepts up to a #5 braided suture
- » Open and arthroscopic applications
- » Available in pre-loaded StitchPak® (w/two #2 polyester sutures) or individually

Cat. No.

Implants

UltraFix RC Anchor, 2.9mm dia. Anchor & Suture on a Disposable Inserter (1 each) (Pre-Threaded w/Two #2 Polyester Sutures)	10125
UltraFix RC Anchor, 2.9mm dia. Anchor Only (1 each).....	10139
UltraFix RC Anchor, 2.9mm dia. Anchor Only (5 each).....	10160A
UltraFix RC StitchPak, 2.9mm dia. Pre-Deployed, Anchor & Suture Only (1 each) (Pre-Threaded w/One #2 Polyester Suture).....	10175
UltraFix RC StitchPak, 2.9mm dia. Anchor & Suture Only (5 each) (Pre-Threaded w/One #2 Polyester Suture).....	10170A
UltraFix RC StitchPak, 2.9mm dia. Anchor & Suture Only (1 each) (Pre-Threaded w/Two #2 Polyester Suture).....	10282

Instruments

Drill Guide, Duckbill, Slotted.....	10004A
Drill Bit, 3.2mm dia.	10025
Insertion Gun.....	10085
Arthroscopic Drill Guide, Slotted.....	10095A
Arthroscopic Drill, 3.2mm dia.	10093
Arthroscopic Insertion Gun.....	10121
UltraFix Sterilization Tray.....	10053

All products may not be available in all markets.

Mini-Open Rotator Cuff Repair System

The Mini-Open Rotator Cuff Repair System facilitates open rotator cuff surgery by reducing procedure time, incision size and the likelihood of stress risers. This system augments other rotator cuff repair systems and implants. The system is comprised of three sizes of matched cortical gauge punches, circular bone rasps, and suture retrievers.

Instruments

	Cat. No.
Circular Bone Rasp, Small, Yellow	61.1002
Circular Bone Rasp, Medium, Blue	62.1002
Circular Bone Rasp, Large, Green	63.1002
Cortical Gauge Punch, Small, Yellow	61.2001
Cortical Gauge Punch, Medium, Blue	62.2001
Cortical Gauge Punch, Large, Green	63.2001
Instrument Tray with Lid.....	9895

Accessories

Disposable Suture Retriever, Small, Yellow (6 per Box, Sterile).....	9892
Disposable Suture Retriever, Medium, Blue (6 per Box, Sterile).....	9893
Disposable Suture Retriever, Large, Green (6 per Box, Sterile).....	9894

Additional Instrumentation

Soft Tissue Retractor System

Tissue Retractor Body with Paddles (with 35mm and 50mm Blunt Paddle Sets)	TR1
Tissue Retractor Body.....	TRB1
35mm Paddles Set (Blunt)	TRP35
35mm Paddles Set (Aggressive).....	TRP351
50mm Paddles Set (Blunt)	TRP50
50mm Paddles Set (Aggressive).....	TRP501
75mm Paddles Set (Blunt)	TRP75
75mm Paddles Set (Aggressive).....	TRP751

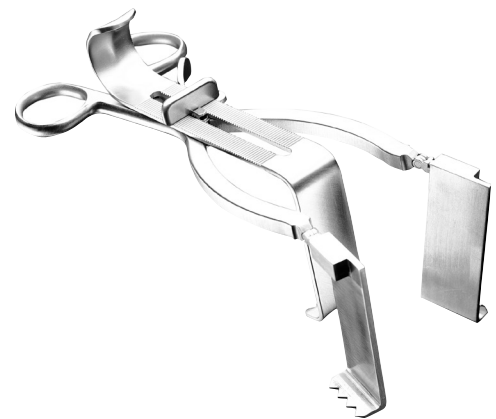
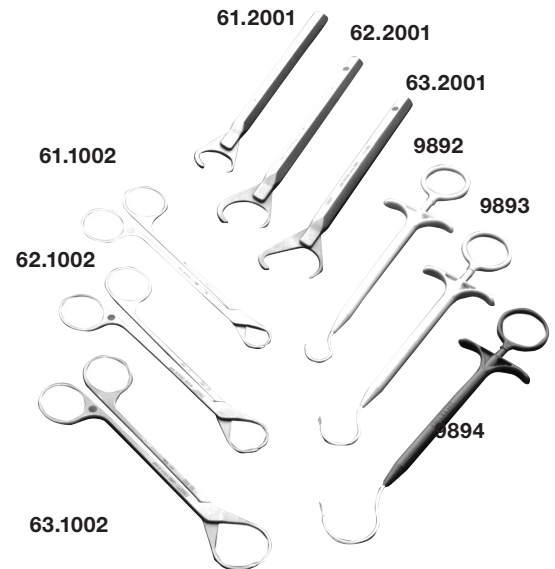

Soft Tissue Retractor

All products may not be available in all markets.



1.3mm Y-Knot® Flex All-Suture Anchor, Single-Loaded

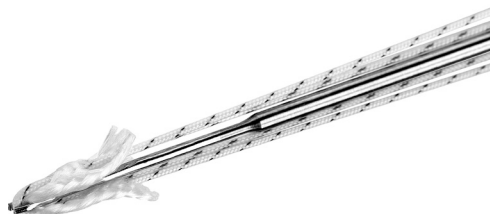

1.8mm Y-Knot® Flex All-Suture Anchor, Double-Loaded



Curved Drill Guide



Drill Bit

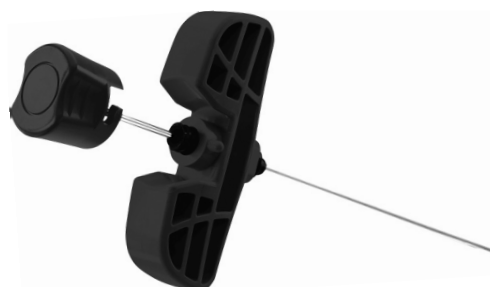

Percutaneous T-Guide

Y-Knot® Flex All-Suture Anchor System

- » Small 1.3mm and 1.8mm options require minimal bone removal
- » Single or Double-loaded with #2 Hi-Fi® Suture
- » Secure 360° FormFit™ Fixation within bone
- » Curved and Percutaneous Delivery Options

Implants

Cat. No.

Y-Knot® Flex All-Suture Anchor, 1.3mm – Single-Loaded with one strand of #2 Hi-Fi	Y1301
Y-Knot Flex All-Suture Anchor, 1.8mm – Double-Loaded with two strands of #2 Hi-Fi	Y1802
Y-Knot Flex All-Suture Anchor w/ blue suture, 1.8mm – Double Loaded with two strands of #2 Hi-Fi	Y1802A

Drill Bits

1.3mm Disposable Drill Bit.....	Y13D
1.8mm Disposable Drill Bit.....	Y18D
1.3mm Disposable Drill Bit, for Hard Bone	Y13DHB

Standard Instrumentation

Drill Guide, Fishmouth.....	Y-G001
Drill Guide, Crown.....	Y-G002
Blunt Obturator.....	Y-G003
Sharp Trocar	Y-G004
Drill Guide, Fishmouth, for 1.8mm Anchor (Optional).....	Y-G005
Drill Guide, Crown, for 1.8mm Anchor (Optional).....	Y-G006

Curved Instrumentation

Curved Drill Guide	Y-CG00
Curved Drill Guide, for 1.8mm Anchor (Optional).....	Y-CG01
Disposable Flexible Obturator, Blunt	Y-OBT1
Disposable Flexible Trocar, Sharp.....	Y-OBT2

Percutaneous Instrumentation

1.3mm Disposable Percutaneous Pack with T-Guide.....	Y-PERC13
1.8mm Disposable Percutaneous Pack with T-Guide.....	Y-PERC18
Disposable Percutaneous Pack for Y-G00x Slim Reusable Guides	Y-PERC
Instrument Tray	C6178

All products may not be available in all markets.

PressFT™ Suture Anchors

- » Available in 2.1 & 2.6 sizes
- » Single or double—loaded with Hi-Fi Suture
- » Radiolucent and revisable with excellent pull-out strength*
- » GENESYS™ biocomposite anchor incorporates microTCP technology

PEEK Implants

2.1 PressFT w/One Strand of #2 (5 metric) Hi-Fi Suture	NP211
2.1 PressFT w/Two Strands of #0 (3.5 metric) Hi-Fi Suture	NP212
2.6 PressFT w/One Strand of #2 (5 metric) Hi-Fi Suture	NP261
2.6 PressFT w/Two Strands of #1 (4 metric) Hi-Fi Suture	NP262

Biocomposite Implants

2.1 GENESYS PressFT w/One Strand of #2 (5 metric) Hi-Fi Suture.....	NB211
2.1 GENESYS PressFT w/Two Strands of #0 (3.5 metric) Hi-Fi Suture.....	NB212
2.6 GENESYS PressFT w/One Strand of #2 (5 metric) Hi-Fi Suture	NB261
2.6 GENESYS PressFT w/Two Strands of #1 (4 metric) Hi-Fi Suture.....	NB262

Instruments

PressFT Drill Bit, 2.1.....	NDB21
PressFT Drill Bit, 2.6	NDB26
Drill Guide, Fishmouth.....	C6171A
Drill Guide, Offset.....	C6172A
Blunt Obturator.....	C6173
Sharp Trocar	C6174
Instrument Tray	C6178
Percutaneous Kit	N-PERC



PressFT™ Suture Anchor

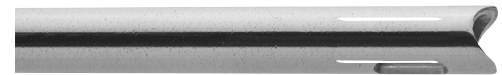

Drill Guide, Fishmouth

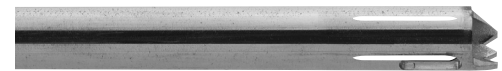

Drill Guide, Offset

*Data on file

All products may not be available in all markets.



Instability PopLok® Anchors

Instability PopLok® Anchors

2.8mm & 3.3mm PEEK Knotless Anchors

- » Ability to tension suture after anchor is seated for precise control over the repair
- » Suture locks within the anchor for secure suture retention independent of bone quality
- » Press fit ribbed design with sub-cortical wings for additional fixation
- » Tactile and audible “POP” confirms fixation

Cat. No.

Implants

2.8mm Poplok Suture Anchor with One #2 Hi-Fi® Suture	GKP-2801
2.8mm Poplok Suture Anchor with Two #0 Hi-Fi Sutures	GKP-2802
3.3mm Poplok Suture Anchor with One #2 Hi-Fi Suture	GKP-3301
3.3mm Poplok Suture Anchor with Two #0 Hi-Fi Sutures	GKP-3302

Instruments

2.8/3.3mm PopLok Drill Bit	BKL-00M
Instability PopLok Guide.....	BGU-00M



Bio Mini Revo®

Bio Mini Revo® Anchor

3.1mm thread-in style absorbable implant

- » Proven screw-in design ensures optimal purchase in bone
- » High pull-out strength
- » Manufactured from patented Self-Reinforced 96L/4D PLA
- » Pre-threaded with one #2 Hi-Fi Suture



Bio Instability Self-Drilling Bone Tap

Implant

Bio Mini Revo® w/One #2 Hi-Fi Suture, Disposable Driver.....	C6170H
--	--------

Instruments

Bio Mini Revo Drill Bit, 2.1mm.....	C6175
Drill Guide, Fishmouth.....	C6171
Drill Guide, Serrated	C6172
Blunt Obturator.....	C6173
Sharp Trocar	C6174
Bone Punch, 2.1mm	C6176
Self-Drilling Bone Tap, 2.9mm	C6177
Instrument Tray	C6178

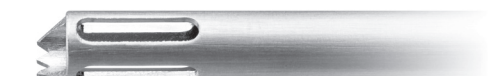

Instability Drill Guide, Serrated



Instability Drill Guide, Fishmouth

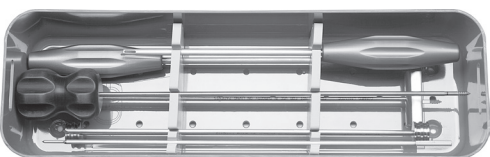

Bio Instability Sterilization Tray

All products may not be available in all markets.

Mini Revo® Suture Anchor System

Screw-in titanium 2.7mm implant provides superior bone purchase

Implants

	Cat.No.
Mini Revo Suture Anchor, Pre-Threaded with #2 Polyester Suture, 2.7mm O.D. x 8.5mm L, Implant and Suture Only.....	C6109A
Mini Revo Suture Anchor, Pre-Threaded with #2 Hi-Fi® Suture, 2.7mm O.D. x 8.5mm L, Implant and Suture Only.....	C6109H

Instruments

Mini Revo Driver	C6110A
Mini Revo Drill Guide	C6116
Suture Threader	C6113
Mini Revo Bone Punch, 1.5mm dia.....	C6114
Mini Revo Drill Bit, 1.5mm dia.....	C6115A
Mini Revo Tap.....	C6128
Loop Handle Knot Pusher.....	C6112
Crochet Hook	C6105
Low Profile, Slotted Jaw, Suture Punch, 4mm Needle	18.1008
Low Profile, Slotted Jaw, Suture Punch, 7mm Needle	18.100124
Basic Instrument Tray with Lid	C6117
Master Instrument Tray with Lid	C6203

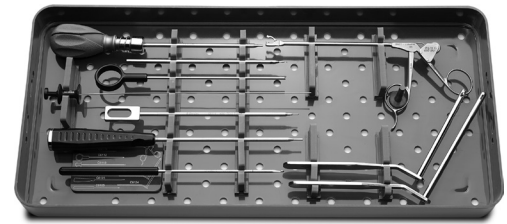

Master Instrument Tray with lid



2.7mm Mini Revo

All products may not be available in all markets.



2.3mm UltraFix® MiniMite®

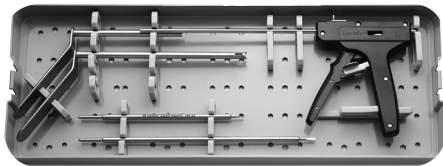

Ultrafix® MiniMite® Suture Anchor System

- » 2.3mm diameter press-in and deployable style implant
- » Removal and repositioning possible prior to final placement
- » Smooth surface until deployed eliminates tissue, bone, and suture damage
- » Ultra smooth eyelet hole preserves suture integrity
- » Uses same instrument set as UltraFix RC® anchors except for drill

Implants

UltraFix MiniMite Anchor, 2.3mm dia., with Threader, 1 each.....	10201
UltraFix MiniMite StitchPak®, 2.3mm dia., (Pre-Threaded W/ #2 Polyester Suture), 1 each	10211
UltraFix MiniMite StitchPak, 2.3mm dia., (Pre-Threaded W/ #2 Polyester Suture), 5 each	10215A

(Implants sold sterile)

Instruments

Drill Guide, Slotted Duckbill.....	10004A
Drill Bit, 2.4mm dia.	10202
Insertion Gun.....	10085
Arthroscopic Drill Guide, Slotted.....	10095A
Arthroscopic Drill Bit, 2.4mm dia.	10206
Arthroscopic Insertion Gun.....	10121
Anchor Tap Down Tool, 2.4mm dia.....	10279
Sterilization Tray	10053

All products may not be available in all markets.

TenoLok® Tenodesis Anchor

The TenoLok Tenodesis Anchor is a dual expanding anchor made of PEEK. It comes in two different diameters (5.0mm and 6.0mm) and is intended for soft tissue to bone fixation. It can be used for arthroscopic or mini-open biceps tenodesis repair or MPFL, MQTFL or ALL for the knee.

The TenoLok Tenodesis Anchor provides a quick and easy repair to reduce steps in the OR such as whipstitching and provides benefits over conventional interference screws like tendon wrapping and tendon damage.

Implants

5.0mm TenoLok Tenodesis Anchor with one #2 Hi-Fi suture.....	T50S
6.0mm TenoLok Tenodesis Anchor with one #2 Hi-Fi suture.....	T60S
6.0mm TenoLok Tenodesis Anchor with distal cleats.....	T60A
<small>(Implants sold sterile)</small>	

Instruments

9" High Strength Guide Pin, 2.4mm dia., sterile (5/Box).....	9742D
Badger® Drill Bit, 6.5mm dia., sterile (4/Box).....	C8593
Badger® Drill Bit, 7.0mm dia., sterile (4/Box).....	C8582
Badger® Drill Bit, 7.5mm dia., sterile (4/Box).....	8593
Badger® Drill Bit, 8.0mm dia., sterile (4/Box).....	C8599
Tendon sizing ring (5 - 8 mm).....	GFT-SM

SutureLoop Hi-Fi Suture

#2 Hi-Fi Suture, 60mm Straight Needle, 20" Loop (12/Box).....	HL200
#2 Hi-Fi Suture, 48mm Curved Needle, 20" Loop (12/Box).....	HL201



**TenoLok®
Tenodesis Anchor**

All products may not be available in all markets.



Spectrum® AutoPass™ Suture Passer

- » Consistent performance in thick tissue
- » Two suture passers in one
- » All-inside suture passing eliminates a step
- » 18mm bite, Fits down 5.5mm cannula
- » Updated needle with optimized piercing tip, strong PEEK tab, and polymer coating for smooth actuation
- » Stiff shaft for durability
- » Anatomic depth markings on jaw in 5mm increments

Cat. No.

Spectrum AutoPass Suture Passer (Reusable)	SMI-02AP
Spectrum AutoPass Needle* (5/Box - Disposable).....	SMI-02D

* Spectrum AutoPass Needle is not compatible with Concept Suture Passer

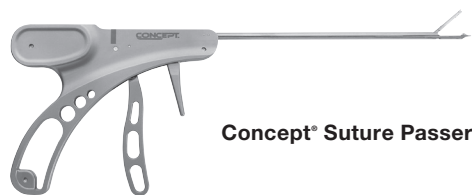

Concept® Suture Passer

Concept® Suture Passer

One-Step Pass-and-Retrieve Lateral Suture Passer

- » Active window to capture and retrieve suture
- » Allows for intraoperative flexibility to release suture in joint
- » Up to 18mm bite of tissue
- » Fits down 5.5mm cannula
- » Designed to be used with #2 Hi-Fi® Suture

Concept Suture Passer Needle



Concept Suture Passer.....	SMI-00M
Concept Suture Passer Needle (5/Box).....	SMI-00D



SeaHawk™ Suture Passer

SeaHawk™ Suture Passer

The SeaHawk Suture Passers are available in four tip configurations – two for labral repair and two for rotator cuff.

- » Designed for arthroscopic or open suturing of soft tissue
- » Unique “Single-pass” instrument
- » Pass and retrieve with one device
- » Designed to work with #2 sutures



Medium Crescent Hook

SeaHawk Suture Passer (left, up)	GU2000
SeaHawk Suture Passer (right, up)	GU2001
SeaHawk RC Suture Passer (left, down).....	GU2002
SeaHawk RC Suture Passer (right, down).....	GU2003



45° Right Hook



45° Left Hook

Spectrum® MVP™ Suture Passer

- » Designed for arthroscopic or open suturing of soft tissue
- » Unique “Single-pass” instrument
- » Pass and retrieve with one device
- » Designed to work with #2 sutures



Spectrum® MVP™ Suture Passer

Medium Crescent Hook, Disposable, Packaged Sterile, 3/Box.....	C6400
45° Right Hook, Disposable, Packaged Sterile, 3/Box.....	C6410
45° Left Hook, Disposable, Packaged Sterile, 3/Box.....	C6420

All products may not be available in all markets.

Spectrum® II Soft Tissue Repair System

- » Designed for arthroscopic or open suturing of shoulder soft tissue
- » Large roller wheels increase traction with Shuttle Relay™ and suture material
- » Disposable and Limited Reuse interchangeable suture hooks allow precise suture placement in otherwise hard-to-reach areas
- » Ergonomic handle design provides ease of maneuverability and handling
- » Unique key-lock insertion method allows for simple and reliable suture hook attachment
- » For use with #2/0 to #1 monofilament suture, Shuttle Relay or with Super Shuttle® Suture Passer

Spectrum II Instruments

	Cat. No.
Spectrum II Handle	C6350
Spectrum II Sterilization Tray	C6355
Spectrum II Roller Wheel Replacement Kit	C6356

Limited Reuse Suture Hooks

Suture Hook, 45° Right	C6360
Suture Hook, 45° Left	C6361
Suture Hook, 60° Right	C6362
Suture Hook, 60° Left	C6363
Suture Hook, 90° Right	C6364
Suture Hook, 90° Left	C6365
Suture Hook, CorkScrew, Right	C6366
Suture Hook, CorkScrew, Left	C6367
Suture Hook, Straight	C6368
Suture Hook, Crescent, Small, 3.0 x 15.0mm	C6369
Suture Hook, Crescent, Medium, 4.0 x 20.0mm	C6370
Suture Hook, Crescent, Large, 6.0 x 25.0mm	C6371

Disposable Suture Hooks (Sterile 5/Box)

Suture Hook, 45° Right (Red)	C6380
Suture Hook, 45° Left (Blue)	C6381
Suture Hook, 60° Right (Orange)	C6382
Suture Hook, 60° Left (Yellow)	C6383
Suture Hook, Straight (Pink)	C6384
Suture Hook, Crescent, Small, 3.0 x 15.0mm (White)	C6385
Suture Hook, Crescent, Medium, 4.0 x 20.0mm (Teal)	C6386
Suture Hook, Crescent, Large, 6.0 x 25.0mm (Purple)	C6387



Spectrum® II Handle

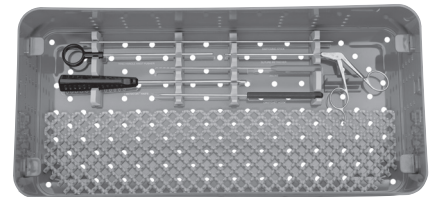
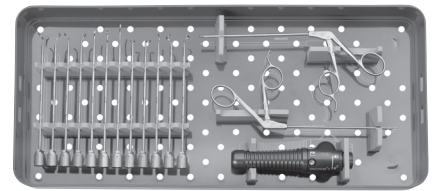

Spectrum II Sterilization Tray

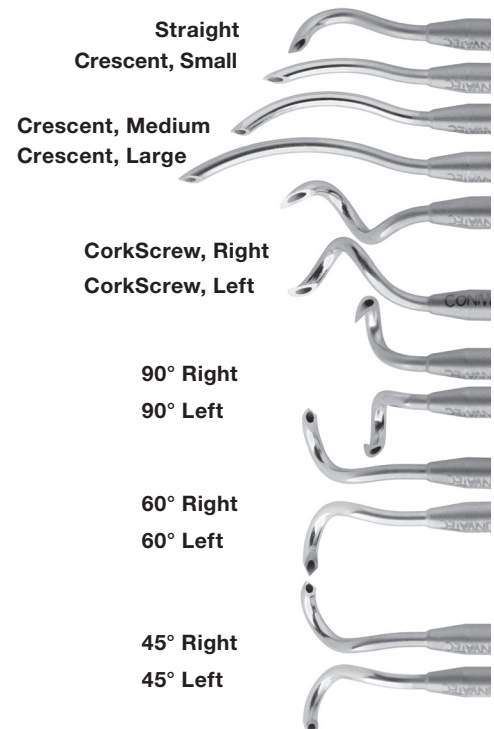

All products may not be available in all markets.

Super Shuttle® Suture Passer

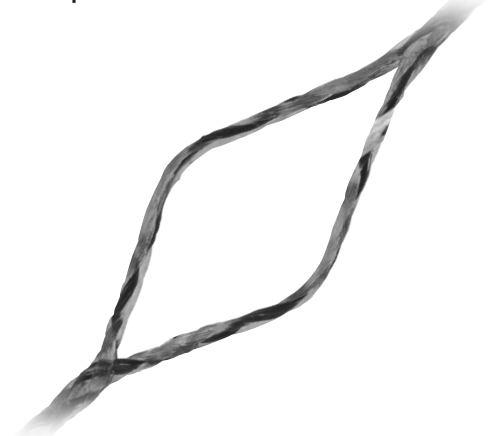

Crochet Hook

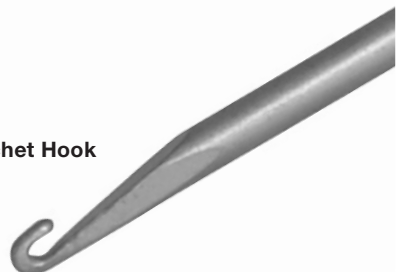

Grasping Forceps



Suture Retrieval Forceps



Super Shuttle® Suture Passer

- » Allows suture to be passed in soft tissue repair procedures
- » Can be used in conjunction with Spectrum® I and II, hollow needles and punches
- » 3 High strength eyelets
- » Low profile pass

Cat. No.

Super Shuttle Suture Passer (Sterile, 8/Box)..... C6005

Spectrum® II Accessories

Loop Handle Knot Pusher..... C6112
 Crochet Hook C6105
 Grasping Forceps, 3.4mm dia., Straight w/Ratchet 11.1001
 Suture Retrieval Forceps, 3.4mm dia..... 16.1018
 Katana® High-strength Suture Cutter..... GU1009
 Micro-Scissors, 2.75mm dia., Straight 2.10011
 Suture Scissor, 3.5mm dia., Straight (For Braided Polyester,
 High Strength or Monofilament Suture) GU1005
 Liberator™ Knife.....25.50014
 Rasp Liberator Knife II25.50016
 Rasp, 30 degree, Top and Bottom Serrations.....C8537.1
 Mini-Probe, 3.5mm dia., Straight..... 21.1001
 Suture Saver™ Kit (5/Box) C6180
 Switching Stick, 254mm x 3.2mm (2/Box)..... 2220

Original Spectrum Instruments

Suture Hook Handle.....27.00011
 Mini-Probe, 3.5mm dia., Straight (Blue Handle) 21.1001
 Suture Retrieval Forceps..... 16.1018
 Micro-Scissors, 2.75mm dia., Straight 2.10011

Original Spectrum Suture Hooks

Suture Hook, Straight97.10015
 Suture Hook, 45° Left Curve.....97.14115
 Suture Hook, 45° Right Curve.....97.14215
 Suture Hook, 90° Left Curve.....97.19115
 Suture Hook, 90° Right Curve.....97.19215
 Suture Hook, Left Corkscrew97.10115
 Suture Hook, Right Corkscrew97.10215
 Crescent Suture Hook, Small Curve, 3 x 15mmC8740
 Crescent Suture Hook, Medium Curve, 4 x 20mmC8741
 Crescent Suture Hook, Large Curve, 6 x 25mm.....C8742

Suture hooks and crescent suture hooks are limited reuse.

Spectrum Accessories

Suture Saver™ Kit (5 Kits per Box) C6180
 Teaser® Knot Tier..... C8004
 Loop Handle Knot Pusher.....C6112
 Replacement Cannula, without Seals..... C8746A
 Replacement Trocar..... C8746B
 Replacement Obturator C8746C
 Replacement Seals for Lipped Cannula (Latex Free, 2 per Set, 5 Sets per Box)..... 8747
 Shuttle Relay™ Suture Passer (10 per Box, Sterile)..... C6004

All products may not be available in all markets.

MASTER Arthroscopy Shoulder Instrument Set

The MASTER Arthroscopy Shoulder Instrument Set is a comprehensive set of manual instruments that can be used for arthroscopic or mini-open shoulder repairs. The set has been designed to allow flexibility in suture passing and suture retrieving methods that are critical to success in these procedures.

Raven™ Suture Retriever

	Cat. No.
Straight, 3.5mm dia., 138mm.....	GU1004
35° Up, 3.5mm dia., 138mm.....	GU1008

Suture Snare™

Straight, 3.5 dia., 138mm.....	GU1003
--------------------------------	--------

Katana® High-Strength Suture Cutter

.....	GU1009
-------	--------

Suture Scissor

Straight, 3.4 dia., 136mm.....	GU1005
--------------------------------	--------

Tissue Grasper

Straight, 3.5 dia., 142mm.....	GU1002
--------------------------------	--------

Accessories

Arthroscopic Probe.....	PR1001
Crochet Hook.....	PR1002
Loop Handled Knot Pusher.....	C6112
Switching Stick.....	2220
Instrument Tray.....	MT1006

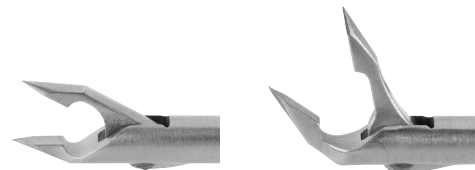

Raven™ Suture Retriever, Straight

Raven Suture Retriever, 35° Up



Suture Snare™ Straight

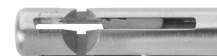

Katana® High-Strength Suture Cutter



Suture Scissor



Tissue Grasper



Instrument Tray

All products may not be available in all markets.



Shutt® Suture Punch System

- » Enables the surgeon to arthroscopically suture Bankart lesions, rotator cuff tears and incomplete ACL tears
- » Use with standard 2/0 to #1 monofilament suture, or in conjunction with the Shuttle Relay™ suture passer when braided suture is desired, with a slip resistant roller system
- » The arthroscopic suture passer or drill bit provides proper suture passage

Instruments Cat. No.

Suture Punch, 2.5mm Needle, Straight, Slotted.....	18.100162
Suture Punch, 2.5mm Needle, Straight, Low Profile.....	18.100163
Suture Punch, 2.5mm Needle, Straight, Slotted and Low Profile.....	18.100164
Suture Punch, 4.0mm Needle, Straight.....	18.1007
Suture Punch, 4.0mm Needle, Straight, Slotted and Low Profile.....	18.1008
Suture Punch, 4.0mm Needle, Left, Low Profile.....	18.100113
Suture Punch, 6.0mm Needle, Right, Slotted and Low Profile.....	18.100135
Suture Punch, 6.0mm Needle, Left, Slotted and Low Profile.....	18.100145
Suture Punch, 6.0mm Needle, Straight, Low Profile..... (Pass 2/0 to #2 Monofilament Suture)	18.100157
Suture Punch, 7.0mm Needle, Straight.....	18.10012
Suture Punch, 7.0mm Needle, Straight, Low Profile.....	18.100123

Accessories

Arthroscopic Suture Passer 3.0mm, Sharp.....	18.00015
Suture Punch, 7mm Needle, Cannula.....	9856
Suture Punch, 7mm Needle, Cannula, Slotted.....	9856A
Replacement Obturator (White Plastic).....	A55-114-02
Replacement Trocar (Metal).....	A55-114-027
Replacement Seal with Slit.....	C6901
Switching Stick, .125" x 10" (2 per Box).....	2220
Cannulated Obturator (Amber, Matches 9856 and 2220).....	9854
Suture Punch Drill Guide (includes 2 Drill Bits).....	8755
Suture Drill Bit, 3.3mm.....	8757
Shuttle Relay Suture Passer (10 per Box, Sterile).....	C6004



All products may not be available in all markets.

Suture Saver™ Kit

- » Helps manage suture pairs prior to knot tying
- » Reduces tissue prior to knot tying for accurate assessment of the repair
- » Sheaths may be placed inside or outside of the working cannula
- » Brightly colored sheaths are easy to see arthroscopically
- » One kit includes 5 sheaths and 1 threader

Cat. No.

Suture Saver™ Kit (Single-Use, 5 Kits per Box, Sterile) C6180

Hawkeye® Suture Needle

The Hawkeye Suture Needle is a versatile suture passing and retrieving instrument. It is ideal for most arthroscopic tissue repairs in the knee and shoulder and can be used in conjunction with suture anchors. The Hawkeye needle's atraumatic eyelet design protects the suture from abrasion and inadvertent damage.

Hawkeye Suture Needle C6001
(Single-Use, 6 per Box, Sterile)

Blitz® Suture Retriever

- » For arthroscopic and open soft tissue repair procedures
- » Simplicity of design eliminates complicated procedural steps
- » May be used with any type or size of suture material and in conjunction with anchors or screws (including suture pre-assembled to an anchor)
- » A small, curved needle tip permits placement of a variety of stitch patterns, and improves access to all hard-to-reach tears
- » A durable nitinol loop deploys, then pulls suture back through the tissue

Straight (6 per Box, Sterile) C6111

45° Left (6 per Box, Sterile) C6211

45° Right (6 per Box, Sterile) C6311

Accessories

Loop Handle Knot Pusher C6112

Liberator™ Knife 25.50014

Rasp Liperator Knife II (Added Rasping Surface) 25.50016

Driver Extractor DE100

Accommodates most Driver Shaft diameters
Aids in the removal of Driver Arm fixation site



Suture Saver Kit

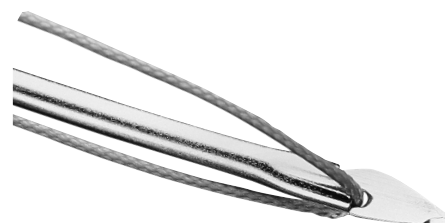

Hawkeye Suture Needle



Blitz Suture Retriever



Loop Handle Knot Pusher

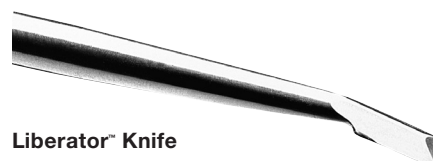

Liberator™ Knife

All products may not be available in all markets.



Hi-Fi® Suture

Hi-Fi Suture, Ultra High Molecular Weight Polyethylene, is a braided, nonabsorbable suture indicated for soft tissue repair in orthopedic procedures. The high performance fiber used to create the braided suture is extremely strong and provides exceptional strength for knot tying. The unique construction of the suture creates low-profile knots. In addition, the inherent material characteristics of the suture provide ease of use for suture passing and tying.

- » High performance fiber for superior fixation
- » Exceptional strength for knot tying
- » Enhanced feel for suture passing
- » Unique construction for low-profile knots

	Cat. No.
#2 Hi-Fi Suture, 12/Box, Single 40" Strand, White C-2 .5" Circle, Tapered Needle	H5000
#2 Hi-Fi Suture, 12/Box, Single 40" Strand, Blue, 26mm .5" Circle, Tapered Needle	H6110T
#2 Hi-Fi Suture, 12/Box, Single 40" Strand, Blue 26mm .5" Circle, Reverse Cutting Needle	H6120RC
#2 Hi-Fi Suture, 12/Box, Single 40" Strand, Blue 40mm .5" Circle, Reverse Cutting Needle	H6140RC
#2 Hi-Fi Suture, 12/Box, Single 40" Strand, Blue 26mm .5" Circle, Tapered, Two Needles, One on Each End	H6150T2
#2 Hi-Fi Suture, 12/Box, Two 40" Strands, White and White-Blue Co-Braid, C-2 .5". Circle, Tapered Needles	H5100
#2 Hi-Fi suture, 12/Box, Two 40" Strands, Blue and White-Black Co-Braid, 26mm .5" Circle Tapered Needle	H6210T
#2 Hi-Fi Suture, 12/Box, Single 40" Strand, Blue No Needle	H6100
#2 Hi-Fi Suture, 12/Box, Single 36" Strand, White-Blue Co-Braid, No Needle	H5120
#2 Hi-Fi Suture, 12/Box, Single 36" Strand, White, No Needle	H5130
#2 Hi-Fi Suture, 12/Box, Single 36" Strand, White-Black Co-Braid, No Needle	H5150
#2 Hi-Fi Suture, 12/Box, Single 36" Strand, White-Green Co-Braid, No Needle	H5140
#2 Hi-Fi suture, 12/Box, Two 40" Strands Blue and White-Black Co-Braid, No Needle	H6200
#5 Hi-Fi Suture, 12/Box, Single 36" Strand, White-Blue Co-braid HSCX48 .5" Cutting Needle	H5200
#5 Hi-Fi Suture, 12/Box, Single 36". Strand, White-Blue Co-Braid, No Needle	H5250
#0 Hi-Fi Suture, 12/Box, Single 36". Strand, White-Blue Co-Braid C-4 .5" Tapered Needle	H5300
#0 Hi-Fi Suture, 12/Box, Single 36" Strand, White-Black Co-Braid No Needle	H5301
#0 Hi-Fi Suture, 12/Box, Single 36" Strand, White, No Needle	H5302
#0 Hi-Fi Suture, 12/Box, Single 36" Strand, White-Green Co-Braid No Needle	H5303
#0 Hi-Fi Suture, 12/Box, Single 36" Strand, White-Blue Co-Braid HRT22 .5" diamond point needle	H5400
#2-0 Hi-Fi Suture, 12/Box, Single 36" Strand, White-Blue Co-Briad HR20 .5". Tapered Needle	H5500
#2-0 Hi-Fi Suture, 12/Box, Single 36" Strand, White-Blue Co-Braid HRT20 .5" Diamond Point Needle	H5600

All products may not be available in all markets.

ARC™ Adjustable Retractor Cannula

The ARC Adjustable Retractor Cannula helps surgeons see more clearly, operate with greater range of motion and minimize cannula pull-out. The proprietary locking nut and distal wing design of this cannula retracts the deltoid fascia to create a large space for better visualization. The ARC has a triple seal design, is made of silicone and is latex free. Two diameters and lengths are offered, with an optional outflow port.

	Cat. No.
ARC 6.0mm x 65mm, Green, Sterile, 6/Box.....	C06-65
ARC 6.0mm x 85mm, with Outflow, Green, Sterile, 6/Box	C06-85
ARC 8.0mm x 65mm, Purple, Sterile, 6/Box	C08-65
ARC 8.0mm x 85mm, with Outflow, Purple, Sterile, 6/Box.....	C08-85
14cm Forceps, Sterile, 6/Box	SU-9-0183-14

Dry-Doc® Cannula System

The Dry-Doc cannulas are the first smooth/pleated cannulas on the market! They have a unique patented design that incorporates a semi-flexible inner tube covered with an accordion-like outer sleeve. The insertion feels like a smooth cannula. After insertion, the outer sleeve of the Dry-Doc cannula acts as pleats, gently filling the portal channel thus preventing inadvertent back-out.

- » Hex cap interface
- » Patented, semi-flexible outer sleeve
- » Rounded distal tip
- » Semi-translucent colored cannulas
- » Ratcheting stopcock for controlled outflow
- » Non-latex, double seals

Dry-Doc Cannula, 5.0mm x 85mm, Translucent Green, Packaged Sterile, with a Disposable Obturator, 6/Box	C7350
Dry-Doc Cannula, 6.0mm x 85mm, Translucent Gray, Packaged Sterile, with a Disposable Obturator, 6/Box	C7359
Dry-Doc Cannula, 7.0mm x 85mm, Translucent Blue, Packaged Sterile, with a Disposable Obturator, 6/Box	C7360
Dry-Doc Cannula, 7.0mm x 95mm, Translucent Blue w/ Black cap, Packaged Sterile, with a Disposable Obturator, 6/Box	C7369
Dry-Doc Cannula, 8.0mm x 75mm, Translucent Red, Packaged Sterile, with a Disposable Obturator, 6/Box	C7367
Dry-Doc Cannula, 8.0mm x 85mm, Translucent Yellow, Packaged Sterile, with a Disposable Obturator, 6/Box	C7368

Hex Flex® Cannula

The pliable, bendable, ultra-durable, cannula.

- » Two distal spiral threads provide a sturdy, yet atraumatic hold in capsule
- » Smooth shaft for easy manipulation of cannula
- » Click-lock ratcheting stopcock for meticulous fluid control

5.0mm x 85mm Hex Flex Cannula, Translucent Green Packaged Sterile, with Disposable Obturator, 6/Box	C7450
6.0mm x 85mm Hex Flex Cannula, Translucent Gray Packaged Sterile, with Disposable Obturator, 6/Box	C7455
7.0mm x 85mm Hex Flex Cannula, Translucent Blue Packaged Sterile, with Disposable Obturator, 6/Box	C7465
8.0mm x 85mm Hex Flex Cannula, Translucent Yellow Packaged Sterile, with Disposable Obturator, 6/Box	C7480

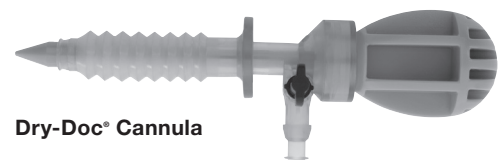
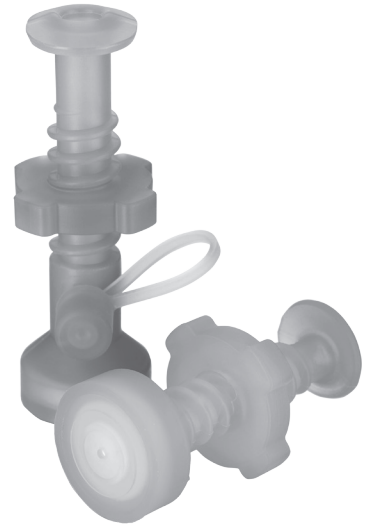

Dry-Doc® Cannula



Hex Flex® Cannula

All products may not be available in all markets.



**Cannulated Obturator,
Green**



**Cannulated Obturator,
Blue**



**Cannulated Obturator,
Red**



**Cannulated Obturator,
Yellow**



**Universal
Cannula Set**

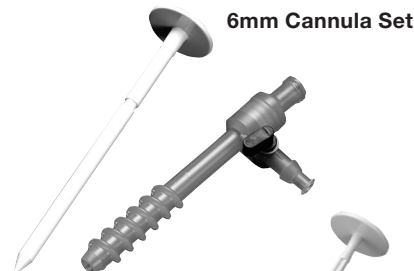

6mm Cannula Set



8.4mm Cannula Set

Reusable Obturators

For use with Dry-Doc and Hex Flex cannulae.

	Cat. No.
Cannulated Obturator (5.0mm x 85mm), Green for use with Green Dry-Doc (C7350) and Green Hex Flex (C7450)	C7380
Cannulated Obturator (6.0mm x 85mm), Gray for use with Gray Dry-Doc (C7359) and Gray Hex Flex (C7455)	C7382
Cannulated Obturator (7.0mm x 85mm), Blue for use with Blue Dry-Doc (C7360) and Blue Hex Flex (C7465)	C7385
Cannulated Obturator (7.0mm x 95mm), Black for use with Blue-Black Dry-Doc (C7369)	C7388
Cannulated Obturator (8.0mm x 75mm), Red for use with Red Dry-Doc (C7367)	C7390
Cannulated Obturator (8.0mm x 85mm), Yellow for use with Yellow Dry-Doc (C7368) and Yellow Hex Flex (C7480)	C7395

Universal Cannula Set

Smooth 5.5mm gray plastic cannula

- » 5.5mm internal diameter
- » 70mm working length
- » Non-conductive material for electrosurgical procedures
- » Connector allows positive connection to some CONMED blades and burs
- » Integral double seal prevents backwash of fluids
- » Sharp and blunt trocars included
- » Packaged sterile, single-use, ten per box

70mm Universal Cannula Set, with Fenestrations, 10/Box	9704
70mm Shoulder Cannula Set, without Fenestrations, 10/Box	9718

Disposable Cannula

Rigid, translucent, disposable cannula.

- » Translucent cannula body allows visualization of passing instrumentation or suture
- » Dual silicone seal system to prevent fluid leakage
- » Integrated flow control valve
- » Both luer and .25" tube connection on a single fluid port
- » Disposable conical obturator included
- » Packaged sterile, single-use, six per box

6 x 50mm, Threaded, 6/Box	C7322
6 x 50mm, Smooth, 6/Box	C7324
6 x 75mm, Threaded, 6/Box	C7332
6 x 75mm, Smooth, 6/Box	C7334
6 x 90mm, Threaded, 6/Box	C7342
6 x 90mm, Smooth, 6/Box	C7344
8.4 x 50mm, Threaded, 6/Box	C7352
8.4 x 50mm, Smooth, 6/Box	C7354
8.4 x 75mm, Threaded, 6/Box	C7362
8.4 x 75mm, Smooth, 6/Box	C7364
8.4 x 90mm, Threaded, 6/Box	C7372
8.4 x 90mm, Smooth, 6/Box	C7374

All products may not be available in all markets.

Reusable Cannulated Obturator

For use with Disposable Cannula

» Will fit 3.17mm (.125") switching sticks.

	Cat. No.
Obturator, Fits 6 x 50mm.....	C7325
Obturator, Fits 6 x 75mm.....	C7335
Obturator, Fits 6 x 90mm.....	C7345
Obturator, Fits 8.4 x 50mm.....	C7355
Obturator, Fits 8.4 x 75mm.....	C7365
Obturator, Fits 8.4 x 90mm.....	C7375

Clear Flexible Cannula

Translucent, bendable, pliable cannula

Characteristics:

- » Flexible body
- » See-through design
- » Abrasion resistant
- » Inflow/outflow stopcock
- » Disposable Obturator included
- » Packaged sterile, single-use, six per box

6.5mm x 73mm Clear Flexible Cannula:

Threaded, 6/Box.....	C7312
Smooth, 6/Box	C7313
Reusable Cannulated Obturator.....	9828



Threaded



Smooth



The Clear Flexible Cannula adapts to the size and shape of most instruments without the concern of debris and skiving.

All products may not be available in all markets.



**AssistArm™
Limb Positioner**



BeachChair



Shoulder Holder

AssistArm™ Limb Positioner

The AssistArm Limb Positioner assures smooth, effortless and stable limb placement so the surgical team can focus on the procedure, not on holding the limb steady. The AssistArm is powered by hydraulic fluid and does not require electric, batteries or compressed air. The AssistArm can be used to position the shoulder in beach chair or lateral decubitus, knee and ankle for open or arthroscopic procedures.

Positioner

	Cat. No.
AssistArm Limb Positioner	AA-PSN100

Attachments

Arm Support for Beach Chair	AA-AS-BC200
Connector	AA-CON250
Traction Unit	AA-TRAC400
Arm Support for Lateral Decubitus	AA-AS-LD500
Knee	AA-K600
Ankle	AA-A700

Disposable Kits

Disposable Kit for Shoulder and Knee, Packaged Sterile, 10/Box	AA-SK-KIT10
Disposable Kit for Ankle, Packaged Sterile, 10/Box	AA-A-KIT10

BeachChair Shoulder Positioning System

The BeachChair Shoulder Positioning System has been designed to provide the surgeon a secure method of performing arthroscopic and open shoulder surgery with the patient in a seated position. The use of the BeachChair reduces the possibility of neurapraxia associated with the use of traction when arthroscopy is performed with the patient in the lateral decubitus position. This device will lock onto all standard operating room tables and is easily adjustable for patient height and amount of angle desired. Essential pads, restraints, and positioning wedges are included with initial order.

BeachChair Shoulder Positioning System.....	9880
---	------

Accessories

Head and Neck Positioning Pad with Extension.....	9881
Back Pad	9882
Patient Restraint Set (Head, Chest, Waist).....	9883
Forehead Comfort Pads (30 per Box).....	9884
Positioning Wedges (Left, Right)	9885

Shoulder Holder

- » Designed for upper extremity joint distraction during arthroscopic procedures
- » Adjustable to 0°, 30° and 45° angles to insure proper limb positioning
- » Attaches securely to most hospital beds
- » Designed for use in shoulder, elbow and wrist arthroscopy
- » Includes a vinyl-covered stainless steel cable for strength

Shoulder Holder.....	9840
----------------------	------

All products may not be available in all markets.

Switching Sticks

- » Medical-grade stainless steel
- » Ideal for maintaining proper portal sites

Cat. No.

Switching Sticks .125" dia. x 10" length, Blunt Distal Tip (2 per Box)..... 2220

Switching Stick for QuickLatch® Sheath System 3.0mm O.D. x 14"L.....T4906

Arthroscopic Portal Rod

- » .125" diameter
- » 13" length with conical distal tip
- » Ideal for proper portal placement on opposite side of joint

Arthroscopic Portal Rod..... 2221

Arthroscopic Portal Rod for QuickLatch Sheath System 30mm O.D. x 12" L.....T4907

Magnetic Retriever

For recovery of ferrous metallic objects utilizing magnetic attraction.

Magnetic Retriever.....9970

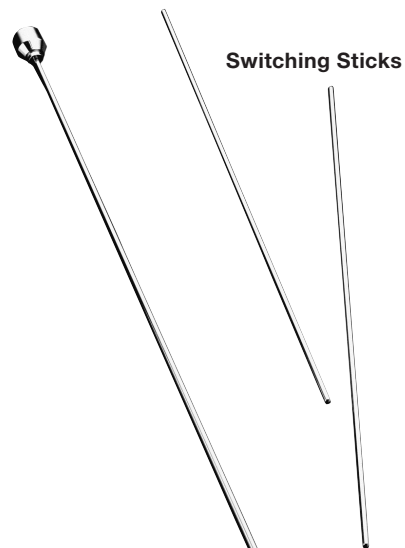

Switching Sticks

Arthroscopic Portal Rod



Magnetic Retriever

All products may not be available in all markets.

KNEE ARTHROSCOPY PRODUCTS

GENESYS™ Matryx® (β-TCP) Interference Screw

The GENESYS Matryx Interference Screw line introduces the latest advancements in proven Biocomposite material technology. The cutting edge GENESYS material is a result of 14 years of extensive research at the CONMED Biomaterials facility in Tampere, Finland. GENESYS utilizes a proprietary micro filtration process that yields β-TCP particles in their smallest form, known as microTCP. These proprietary micro TCP particles are uniformly embedded throughout 96L/4D PLA Bioabsorbable polymer, thereby delivering a stronger Biocomposite material. This technology enables reliable fixation during the healing period while promoting bone in-growth to aid in the restoration of patients' natural anatomy both biologically and mechanically.

	Cat. No.
GENESYS Matryx 5.0 x 15.0mm Interference Screw	235015M5
GENESYS Matryx 5.0 x 20.0mm Interference Screw.....	235020M5
GENESYS Matryx 5.0 x 25.0mm Interference Screw.....	235025M5
GENESYS Matryx 5.0 x 30.0mm Interference Screw.....	235030M5
GENESYS Matryx 5.5 x 15.0mm Interference Screw	235515M5
GENESYS Matryx 5.5 x 20.0mm Interference Screw.....	235520M5
GENESYS Matryx 5.5 x 25.0mm Interference Screw.....	235525M5
GENESYS Matryx 5.5 x 30.0mm Interference Screw.....	235530M5
GENESYS Matryx 6.0 x 15.0mm Interference Screw	236015M5
GENESYS Matryx 6.0 x 20.0mm Interference Screw.....	236020M5
GENESYS Matryx 6.0 x 25.0mm Interference Screw.....	236025M5
GENESYS Matryx 6.0 x 30.0mm Interference Screw.....	236030M5
GENESYS Matryx 6.5 x 15.0mm Interference Screw	236515M5
GENESYS Matryx 6.5 x 20.0mm Interference Screw.....	236520M5
GENESYS Matryx 6.5 x 25.0mm Interference Screw.....	236525M5
GENESYS Matryx 6.5 x 30.0mm Interference Screw.....	236530M5
GENESYS Matryx 7.0 x 20.0mm Interference Screw	237020M5
GENESYS Matryx 7.0 x 25.0mm Interference Screw	237025M5
GENESYS Matryx 7.0 x 30.0mm Interference Screw	237030M5
GENESYS Matryx 8.0 x 20.0mm Interference Screw.....	238020M5
GENESYS Matryx 8.0 x 25.0mm Interference Screw.....	238025M5
GENESYS Matryx 8.0 x 30.0mm Interference Screw.....	238030M5
GENESYS Matryx 8.0 x 35.0mm Interference Screw.....	238035M5
GENESYS Matryx 9.0 x 20.0mm Interference Screw.....	239020M5
GENESYS Matryx 9.0 x 25.0mm Interference Screw.....	239025M5
GENESYS Matryx 9.0 x 30.0mm Interference Screw.....	239030M5
GENESYS Matryx 9.0 x 35.0mm Interference Screw.....	239035M5
GENESYS Matryx 10.0 x 20.0mm Interference Screw.....	231020M5
GENESYS Matryx 10.0 x 25.0mm Interference Screw.....	231025M5
GENESYS Matryx 10.0 x 30.0mm Interference Screw.....	231030M5
GENESYS Matryx 10.0 x 35.0mm Interference Screw.....	231035M5
GENESYS Matryx 11.0 x 20.0mm Interference Screw	231120M5
GENESYS Matryx 11.0 x 25.0mm Interference Screw	231125M5
GENESYS Matryx 11.0 x 30.0mm Interference Screw	231130M5
GENESYS Matryx 11.0 x 35.0mm Interference Screw	231135M5



All products may not be available in all markets.



Cat. No.

Instrumentation for 5.0mm GENESYS™ Matryx®/Matryx Screws

Fixed Tri-Lobe Driver for 5.0mm Interference Screws.....	D8652
Short Modular Tri-Lobe Driver for 5.0mm Interference Screws.....	D8650
Extended Length Modular Tri-Lobe Driver for 5.0mm Interference Screws.....	D8660

Instrumentation for 5.5 – 6.5mm GENESYS Matryx/Matryx Screws

Fixed Tri-Lobe Driver for 5.5 – 6.5mm Interference Screws	D8653
Short Modular Tri-Lobe Driver for 5.5 – 6.5mm Interference Screws.....	D8651
Extended Length Modular Tri-Lobe Driver for 5.5 – 6.5mm Interference Screws.....	D8661

Instrumentation Accessories for 5.0 – 6.5mm GENESYS Matryx/Matryx Screws

Universal Driver, Modular Ratcheting Handle	D8640
Nitinol Guidewire 0.8mm (.032") x 356.0mm (14") (5 per Box)	C8006

Instrumentation for 7.0 – 11.0mm GENESYS Matryx/Matryx Screws

Drivers

Fixed Tri-Lobe Driver for 7.0 – 11.0mm Interference Screws	DFS70
Short Modular Tri-Lobe Driver for 7.0 – 11.0mm Interference Screws.....	DMS70
Extended Length Modular Tri-Lobe Driver for 7.0 – 11.0mm Interference Screws.....	C8716

Taps

7.0–8.0mm, GENESYS Matryx/Matryx Interference Screw Tap, Short Modular	TMS70
7.0–8.0mm GENESYS Matryx/Matryx Interference Screw Tap, Extended Length Modular.....	D8607
9.0–10.0mm, GENESYS Matryx/Matryx Interference Screw Tap, Short Modular	TMS90
9.0–10.0mm GENESYS Matryx/Matryx Interference Screw Tap, Extended Length Modular.....	D8609
11.0mm GENESYS Matryx/Matryx Interference Screw Tap, Short Modular	TMS11
11.0mm GENESYS Matryx/Matryx Interference Screw Tap, Extended Length Modular.....	D8611

Instrumentation Accessories for 7.0 – 11.0mm GENESYS Matryx/Matryx Screws

Universal Driver, Modular Ratcheting Handle.....	D8640
BioScrew HyperFlex® Guidewire 14 x .045" dia. (5 per Box) Nitinol.....	C8026

All products may not be available in all markets.

BioScrew® Bioabsorbable Interference Screw Families

- › Clinically equivalent to metal interference screws
- › Made of Poly (L-Lactic Acid), the screw is gradually absorbed and eventually disappears
- › BioScrew® ensures secure graft fixation throughout the healing process.
- › Any future revision surgery is free of implant removal complications because the screw is absorbed or can simply be overdrilled
- › BioScrew is packaged sterile, single use

BioScrew Bioabsorbable Interference Screws

	Cat. No.
7mm x 20mm	C8010
7mm x 25mm	C8011
7mm x 30mm	C8012
8mm x 20mm	C8017
8mm x 25mm	C8018
8mm x 30mm	C8019
9mm x 20mm	C8013
9mm x 25mm	C8014
9mm x 30mm	C8015
10mm x 25mm	C8022
10mm x 30mm	C8023
11mm x 25mm	C8024
11mm x 30mm	C8025

Guardsman® Style BioScrew Femoral Bioabsorbable Interference Screws

7mm x 20mm	C8030
7mm x 25mm	C8031
7mm x 30mm	C8032
8mm x 20mm	C8037
8mm x 25mm	C8038
8mm x 30mm	C8039
9mm x 20mm	C8033
9mm x 25mm	C8034
9mm x 30mm	C8035

BioScrew XtraLok® Interference Screws

- › Tapered proximal end to seat flush with tibial cortex

XtraLok 8mm x 35mm	C8044
XtraLok 9mm x 35mm	C8027
XtraLok 10mm x 35mm	C8028
XtraLok 11mm x 35mm	C8029
XtraLok 8mm x 40mm	C8043
XtraLok 9mm x 40mm	C8040
XtraLok 10mm x 40mm	C8041
XtraLok 11mm x 40mm	C8042

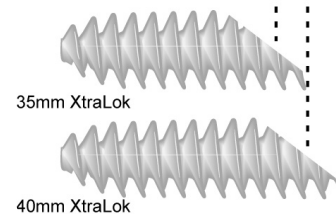

All products may not be available in all markets.



Instrumentation for the BioScrew® Bioabsorbable Interference Screw Families

	Cat. No.
Drivers	
Fixed Tri-Lobe Driver for 7.0 – 11.0mm Interference Screws	DFS70
Short Modular Tri-Lobe Driver for 7.0 – 11.0mm Interference Screws.....	DMS70
Extended Length Modular Tri-Lobe Driver for 7.0 – 11.0mm Interference Screws.....	C8716

Instrumentation Accessories for the BioScrew Interference Screws

Universal Driver, Modular Ratcheting Handle.....	D8640
Guardsman Graft Protector, 7mm.....	C8507
Guardsman Graft Protector, 8 and 9mm.....	C8509
BioScrew Guidewire, 14 x .045" dia. (5 per Box) SST	C8016D
BioScrew HyperFlex® Guidewire, 14 x .045" dia. (5 per Box) Nitinol	C8026D
BioScrew HyperFlex Guidewire, 18.5" x .045" dia. (5 per Box) Nitinol.....	C8027D

All products may not be available in all markets.

Propel® Cannulated Interference Screws

- » Unique, double-helix thread provides unbiased, symmetrical starts, while limiting veering and divergence
- » Specially refined distal end reduces abrasion where it is most critical, offering unequalled protection
- » Aggressive-pitch thread enables screws to be inserted with half the turns of normal screws
- » All Propel screws accept a standard 3.5mm hex driver for confident driving in difficult situations and simpler revisions
- » The Taper-Tip style offers sharper initiating threads and a more pronounced taper for faster, easier insertion

	Non Taper-Tip	Taper-Tip
7mm x 20mm, 3.5mm Hex.....	C8700	C8940
7mm x 25mm, 3.5mm Hex.....	C8710	C8941
7mm x 30mm, 3.5mm Hex.....	C8720	C8942
8mm x 20mm, 3.5mm Hex.....	C8800	C8943
8mm x 25mm, 3.5mm Hex.....	C8810	C8944
8mm x 30mm, 3.5mm Hex.....	C8820	C8945
9mm x 20mm, 3.5mm Hex.....	C8600	C8946
9mm x 25mm, 3.5mm Hex.....	C8610	C8947
9mm x 30mm, 3.5mm Hex.....	C8620	C8948

Implant material is titanium alloy per ASTM F-136.
Packaged sterile, single-use.

CONMED Cannulated Interference Screws

- » CONMED cannulated interference screws have a spiral tip design to limit screw divergence
- » Screws are available in three diameters and five lengths
- » Screws are supplied sterile, complete with guidewire. 7mm, 8mm, and 9mm diameter screws are packaged with .062 inch stainless steel guidewires

	Cat. No.
7mm x 20mm, 3.5mm Hex.....	8970S
7mm x 25mm, 3.5mm Hex.....	8971S
7mm x 30mm, 3.5mm Hex.....	8972S
7mm x 35mm, 3.5mm Hex.....	8973S
8mm x 20mm, 3.5mm Hex.....	C8950
8mm x 25mm, 3.5mm Hex.....	C8951
8mm x 30mm, 3.5mm Hex.....	C8952
9mm x 20mm, 3.5mm Hex.....	8960S
9mm x 25mm, 3.5mm Hex.....	8961S
9mm x 30mm, 3.5mm Hex.....	8962S

Implant material is titanium alloy per ASTM F-136.
Packaged sterile, single-use.

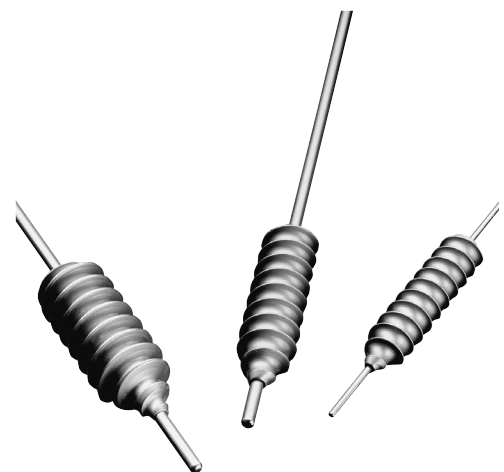
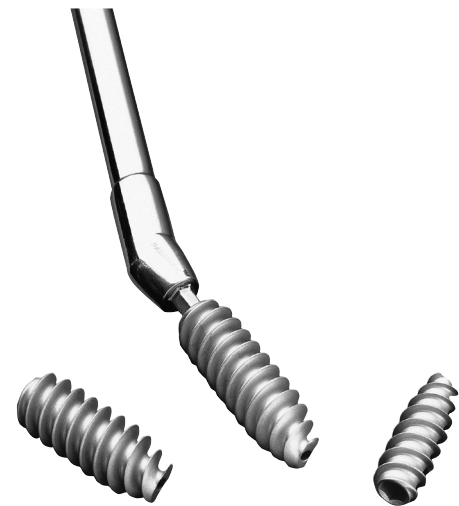

All products may not be available in all markets.

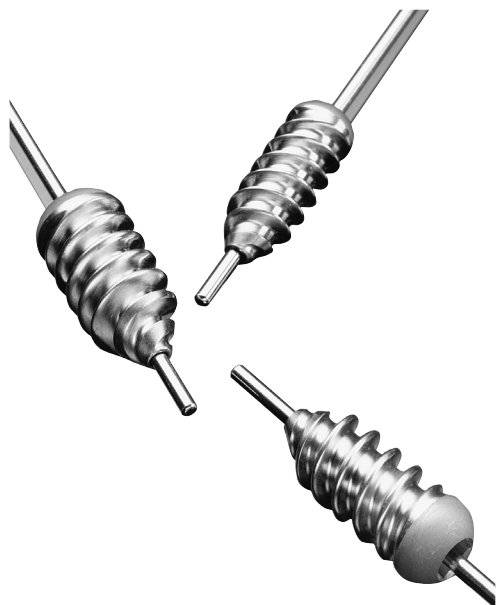

Cat. No.

Instrumentation for the Propel and Cannulated Interference Screws

3.5mm Hex Cannulated Driver, Fixed.....	8608
3.5mm Hex Flexible Cannulated Driver, Fixed.....	C8617
3.5mm Straight Hex, Modular.....	D8626
3.5mm Thin Shaft Hex, Modular.....	D8627

Instrumentation Accessories for the Propel and Cannulated Interference Screws

Modular Ratcheting Handle.....	D8640
Guardzman® Graft Protector, 7mm.....	C8507
Guardzman Graft Protector, 8 and 9mm.....	C8509
HyperFlex® Guidewire, 9" x .062" dia. (5 per Box) Nitinol.....	8571D
HyperFlex Guidewire, 14" x .062" dia. (5 per Box) Nitinol.....	8572D
HyperFlex Guidewire, 18.5" x .062" dia. (5 per Box) Nitinol.....	8573D

Guardzman® Interference Screws

- » Specifically designed for endoscopic femoral fixation where graft protection is needed
- » Polished, fully radiused threads provide maximum graft protection
- » Non-glare head improves visualization and avoids postoperative soft tissue abrasion
- » Double-helix threads for un-biased and rapid advancement
- » Wide-bore cannulation for easy guidewire removal
- » The Taper-Tip style offers sharper initiating threads and a more pronounced taper for faster, easier insertion

5.0mm x 15mm, 2.5mm Hex.....	255015
5.0mm x 20mm, 2.5mm Hex.....	255020
5.0mm x 25mm, 2.5mm Hex.....	255025
5.0mm x 30mm, 2.5mm Hex.....	255030
5.5mm x 15mm, 2.5mm Hex.....	255515
5.5mm x 20mm, 2.5mm Hex.....	255520
5.5mm x 25mm, 2.5mm Hex.....	255525
5.5mm x 30mm, 2.5mm Hex.....	255530
6.0mm x 15mm, 2.5mm Hex.....	256015
6.0mm x 20mm, 2.5mm Hex.....	256020
6.0mm x 25mm, 2.5mm Hex.....	256025
6.0mm x 30mm, 2.5mm Hex.....	256030

	Non Taper-Tip	Taper-Tip
7mm x 20mm, 3.5mm Hex.....	C8320	C8920
7mm x 25mm, 3.5mm Hex.....	C8325	C8921
7mm x 30mm, 3.5mm Hex.....	C8330	C8922
8mm x 20mm, 3.5mm Hex.....	C8420	C8923
8mm x 25mm, 3.5mm Hex.....	C8425	C8924
8mm x 30mm, 3.5mm Hex.....	C8430	C8925
9mm x 20mm, 3.5mm Hex.....	C8520	C8926
9mm x 25mm, 3.5mm Hex.....	C8525	C8927
9mm x 30mm, 3.5mm Hex.....	C8530	C8928

Implant material is titanium alloy per ASTM F-136.
Packaged sterile, single-use.

	Cat. No.
Instrumentation for the 5.0 – 6.0mm	
Guardsmen® Interference Screws	
Cannulated Modular 2.5mm Hex Driver	D8630
Instrumentation Accessories for the 5.0 – 6.0mm	
Guardsmen Interference Screws	
Modular Ratcheting Handle	D8640
Nitinol Guidewire 0.8mm (.032") x 356mm (14") (5 per Box)	C8006D
Instrumentation for the 7.0 – 9.0mm	
Guardsmen Interference Screws	
3.5mm Hex Cannulated Driver, Fixed.....	8608
3.5mm Hex Flexible Cannulated Driver, Fixed.....	C8617
3.5mm Straight Hex, Modular	D8626
3.5mm Thin Shaft Hex, Modular	D8627
Instrumentation Accessories for the 7.0 – 9.0mm	
Guardsmen Interference Screws	
Modular Ratcheting Handle	D8640
Guardsman Graft Protector, 7mm.....	C8507
Guardsman Graft Protector, 8 and 9mm.....	C8509
HyperFlex® Guidewire, 9" x .062" dia. (5 per Box) Nitinol	8571D
HyperFlex Guidewire, 14" x .062" dia. (5 per Box) Nitinol.....	8572D
HyperFlex Guidewire, 18.5" x .062" dia. (5 per Box) Nitinol.....	8573D

All products may not be available in all markets.



Ratcheting Handle



3.5mm Straight Hex, Modular



3.5mm Thin Shaft Hex, Modular



EZ-Out, Modular



2.5mm Hex, Modular



Universal Tri-Lobe Driver, Modular



BioScrew® Tap, 7mm, Modular



BioScrew Tap, 8mm, Modular



GENESYS™ Matryx®/Matryx Interference Screw Tap, Modular

Concept® GraFix® Modular Universal Driver System

The modular system provides the necessary tools to insert or remove CONMED biocomposite, bioabsorbable or metal interference screws during ACL or PCL reconstruction. The handle and attachable shafts provide a cost effective alternative to more expensive fixed drivers and other necessary instruments.

- » Ergonomic ratcheting handle for simple screw insertion and removal
- » Quick connect makes intraoperative shaft changing easy and quick
- » EZ-In and EZ-Out allows for removal or further insertion of broken or misplaced metal, bioabsorbable, or biocomposite interference screws

Cat. No.

Ratcheting Handle D8640

Driver Attachments Metal Interference Screw Drivers

2.5mm Hex, Modular D8630

3.5mm Straight Hex, Modular D8626

3.5mm Thin Shaft Hex, Modular D8627

Bioabsorbable and Biocomposite Interference Screw Drivers

Short Modular Tri-Lobe Driver for 7.0 – 11.0mm Interference Screws..... DMS70

Extended Length Modular Tri-Lobe Driver
for 7.0 – 11.0mm Interference Screws.....C8716

Tap Attachments BioScrew Interference Screw Taps

BioScrew Tap, 7mm, Modular D8637

BioScrew Tap, 8mm, Modular D8638

GENESYS™ Matryx® and Matryx Interference Screw Taps

7.0–8.0mm, GENESYS Matryx/Matryx Interference Screw Tap,
Short Modular TMS70

7.0–8.0mm GENESYS Matryx/Matryx Interference Screw Tap,
Extended Length Modular..... D8607

9.0–10.0mm, GENESYS Matryx/Matryx Interference Screw Tap,
Short Modular TMS90

9.0–10.0mm GENESYS Matryx/Matryx Interference Screw Tap,
Extended Length Modular..... D8609

11.0mm GENESYS Matryx/Matryx Interference Screw Tap, Short Modular TMS11

11.0mm GENESYS Matryx/Matryx Interference Screw Tap,
Extended Length Modular..... D8611

Accessory Attachments

EZ-Out, Modular D8636

GraftMax™ Button Adjustable Cortical Fixation Device

The GraftMax Button gives surgeons the benefits and ease of use of an adjustable loop button, with the graft fixation of a fixed loop.

- » Maximum fixation: reduces displacement by 70%
- » Maximum graft fill: loop is fully adjustable
- » Maximum reproducibility: ease of use compared to competitive designs

Implants

GraftMax™ Button ALB	KS-ALB
GraftMax™ Button BTB	KS-BTB
GraftMax™ Button Cradle	KS-BCA

Cat. No.

XO Button® Titanium: Extra Cortical, Soft Tissue Fixation Implant

The implant of choice for extracortical, soft tissue fixation in cruciate reconstructions.

- » Pre-stretched continuous loop
- » Pre-loaded with passing sutures
- » Integrated method to reposition graft and implant
- » Unique drill bit designed to measure aperture to cortex length

Implants

XO Button® w/15mm Continuous Loop.....	T5015
XO Button w/20mm Continuous Loop	T5020
XO Button w/25mm Continuous Loop	T5025
XO Button w/30mm Continuous Loop	T5030
XO Button w/35mm Continuous Loop	T5035
XO Button w/40mm Continuous Loop	T5040
XO Button w/45mm Continuous Loop	T5045
XO Button w/50mm Continuous Loop	T5050
XO Button w/55mm Continuous Loop	T5055
XO Button w/60mm Continuous Loop	T5060

Cat. No.

GraftMax Button and XO Button Instrumentation

Flex Channel Reamer, 5mm	KC8550
GraftMax Flex XACTPIN®	KS-FGP24
XO Button Drill Bit, 5mm	C8590
XACTPIN® Graft Passing Guide Pin.....	C8677S
Suture Handle	HDL-CLT
XO Button Holder.....	PS8834
EL Depth Probe	21.1001EL

SutureLoop™ Hi-Fi® Suture

#2 Hi-Fi Suture, 60mm Straight Needle, 20" Loop (12 per Box).....	HL200
#2 Hi-Fi Suture, 48mm Curved Needle, 20" Loop (12 per Box).....	HL201

GraftMax™ Button
Adjustable Cortical
Fixation Device



XACTPIN® Graft
Passing Guide
Pin

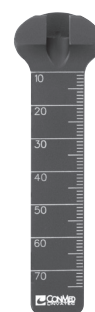
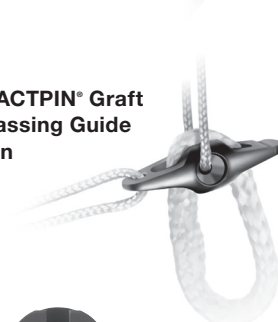

XO Button®
Drill Bit



Depth
Probe

XO Button®
Holder

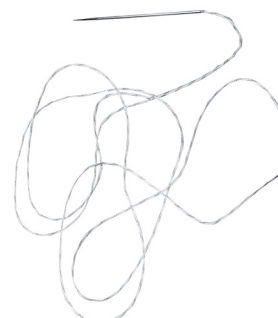

SutureLoop™ Hi-Fi® Suture Straight Needle

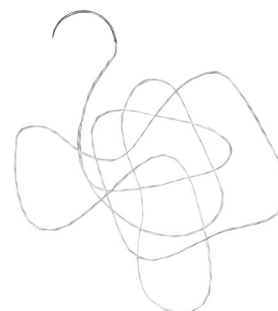

SutureLoop Hi-Fi Suture Curved Needle

All products may not be available in all markets.

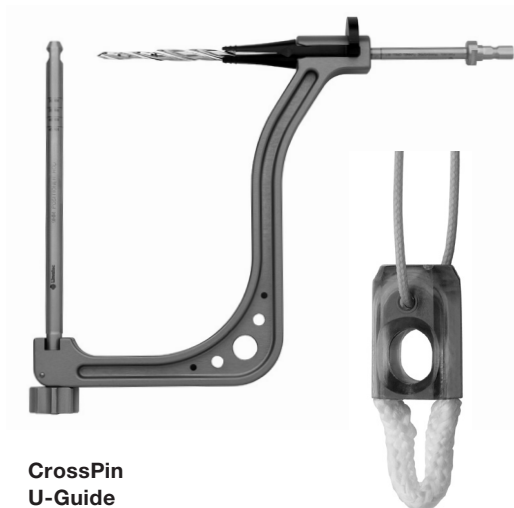

**CrossPin
U-Guide**

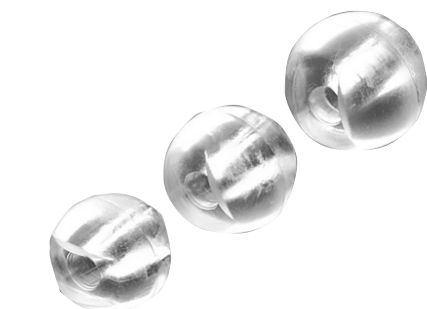

Pinn-ACL® CrossPin System

This system is designed for transverse femoral fixation of soft tissue grafts in ACL reconstruction, allowing for increased pull out strength. The Pinn-ACL® CrossPin System consists of a bioabsorbable Graft Harness implant and CrossPin implant. The Graft Harness is composed of Poly L-Lactic Acid with a high strength polyethylene fiber loop, while the CrossPin implant is composed of Self-Reinforced PLLA.

- » The Pinn-ACL CrossPins' unique surgical technique offers the surgeon the ability to visualize the exact point of femoral fixation
- » Supports and suspends the graft without tissue penetration
- » CrossPin absorption begins in vivo approximately 15 to 24 weeks
- » The Pinn-ACL CrossPin System instruments have an innovative design with a built-in 3-point precision reference system

Cat. No.

Implants

Implant 40mm (15mm) Self-Reinforced CrossPin, Sterile	CPP-4015
Implant 45mm (20mm) Self-Reinforced CrossPin, Sterile	CPP-4520
Implant 50mm (25mm) Self-Reinforced CrossPin, Sterile	CPP-5025
Implant 8mm Graft Harness and Transverse Cannula, Sterile.....	CPH-8000
Implant 9mm Graft Harness and Transverse Cannula, Sterile.....	CPH-9000

Instruments

CrossPin U-Guide	CPS-8902
Implant 8mm Positioning Rod	CPS-8908
Implant 9mm Positioning Rod	CPS-8909
CrossPin Drill Bit.....	CPS-8903
CrossPin Driver.....	CPS-8904

EndoPearl® Fixation Device

The EndoPearl® fixation device is a proprietary, device indicated for use in conjunction with an interference screw. The EndoPearl provides enhanced fixation of soft tissue grafts within the femoral socket during ACL reconstruction.

- » Made of Poly (L-Lactic Acid), the implant is gradually absorbed and eventually disappears
- » Simple method of preparing implant and graft construct
- » Increases graft pullout up to 50%

Cat. No.

Implants

7mm EndoPearl (PLLA).....	C8057
8mm EndoPearl (PLLA).....	C8058
9mm EndoPearl (PLLA).....	C8059

Packaged sterile, single-use.

Soft Tissue Anchoring Screw System

- » The low-profile screw and washer combination provides up to 50% lower profile head than competitive versions
- » Use of a screw and washer set provides continuous strength for soft tissue fixation to bone
- » Unique washer design on the inferior surface provides excellent fixation of soft tissue to bone
- » Washers are available in diameters: 14mm, 17mm, 20mm, and post heights: 1.3mm and 2.5mm
- » Low-profile screws available in 4.5mm cortical and 6.5mm cancellous styles and a full range of lengths. Screw heads are 3.5mm hex

Cortical Screws – Low Profile

Screw outer diameter: 4.5mm; 3.5mm hex

Length	Cat. No.	Length	Cat. No.
30mm.....	C2830	56mm.....	C2856
32mm.....	C2832	58mm.....	C2858
34mm.....	C2834	60mm.....	C2860
36mm.....	C2836	62mm.....	C2862
38mm.....	C2838	64mm.....	C2864
40mm.....	C2840	66mm.....	C2866
42mm.....	C2842	68mm.....	C2868
44mm.....	C2844	70mm.....	C2870
46mm.....	C2846	72mm.....	C2872
48mm.....	C2848	74mm.....	C2874
50mm.....	C2850	76mm.....	C2876
52mm.....	C2852	78mm.....	C2878
54mm.....	C2854	80mm.....	C2880

Cancellous Screws – Low Profile

Screw outer diameter: 6.5mm; 3.5mm hex

Length	Cat. No.
25mm.....	C2610
30mm.....	C2611
35mm.....	C2612
40mm.....	C2613
45mm.....	C2614
50mm.....	C2615
55mm.....	C2616
60mm.....	C2617
65mm.....	C2618

Spiked Washers – Low Profile

Post height: 1.3mm

Diameter	Cat. No.	Post height: 2.5mm	Cat. No.
14mm.....	C2620	14mm.....	C2630
17mm.....	C2621	17mm.....	C2631
20mm.....	C2622	20mm.....	C2632

Flat Washers – Low Profile

Diameter	Cat. No.
14mm O.D.	8814S
17mm O.D.	8817S

Implant materials are titanium alloy per ASTM F-136. Packaged sterile, single-use.

Warning: Cortical and cancellous screws, as well as spiked and flat washers are not approved for screw attachment or fixation to the posterior elements (pedicles) of the cervical, thoracic or lumbar spine.

Cortical Screw

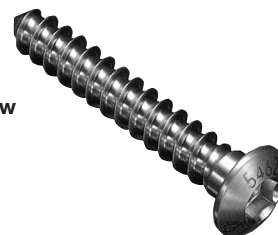

Cancellous Screw



Spiked Washer



Flat Washer



All products may not be available in all markets.



Soft Tissue Anchoring Screw Instruments

Cat. No.

Drivers

3.5mm Hex Cannulated Driver, Fixed.....	8608
3.5mm Hex Flexible Cannulated Driver, Fixed.....	C8617
3.5mm Straight Hex, Modular	D8626
3.5mm Thin Shaft Hex, Modular	D8627
Ratcheting Handle (Attachment for Modular Instruments).....	D8640

Taps

4.5mm Cortical Soft Tissue Bone Tap, Fixed	C2600
6.5mm Cancellous Soft Tissue Bone Tap, Fixed.....	C2601

Drills

Twist Drill, 3.2mm	8604
Twist Drill, 4.5mm	8605

Accessories

Depth Gauge	8579
Screw Pick-up	8606

All products may not be available in all markets.

SE™ (Stress Equalization) Graft Tensioning System

The SE™ Graft Tensioning System provides an accurate and reproducible method for individualizing the tension applied to the soft tissue grafts based on the diameter of each of these graft strands. The result of this strategy in ACL reconstruction is a uniform load distribution across the entire multi-strand graft.

- » Equalized stress between the soft tissue graft bundles
- » In-vivo graft conditioning
- » Posterior tibial loading
- » Centralized screw placement
- » Single surgeon control
- » Reproducible technique and results

	Cat. No.
SE Graft Tensioner.....	C9050
SE Graft Tensioner Drill Guide, 6mm.....	C9051
SE Graft Tensioner Drill Guide, 8mm.....	C9052
SE Graft Tensioner Suture Separators.....	C9053
SE Graft Tensioner Breakaway Pins (Box contains 5 sets of 2 pins).....	C9054
SE Graft Tensioner System Instrument Tray.....	C9055

SE Graft Tensioner Accessories

3.5mm Hex Cannulated Driver, Fixed.....	8608
3.5mm Hex Flexible Cannulated Driver, Fixed.....	C8617
3.5mm Hex, Modular.....	D8626
3.5mm Thin Shaft, Hex, Modular.....	D8627
Ratcheting Handle (attachment for modular instruments).....	D8640
Graft Sizing Block, Grafix®.....	PS8832
Graft Sizing Ring, Large.....	GFT-LG
Graft Sizing Ring, Small.....	GFT-SM



SE Graft Tensioner
Drill Guide



SE Graft Tensioner
Suture Separators

SE Graft Tensioner
Breakaway Pins



SE Graft Tensioner

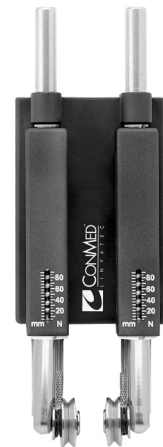

Graft Sizing Block, Grafix®

All products may not be available in all markets.

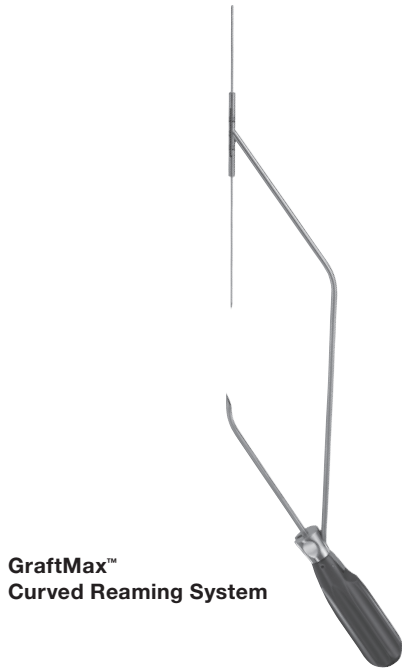

**GraftMax™
Curved Reaming System**



Bullseye® Femoral Off-set Guide



**Bullseye® Femoral
Footprint Guide**



Pinn-ACL Femoral Guides

All products may not be available in all markets.

Femoral Instrumentation

GraftMax™ Curved Reaming System

» The GraftMax™ Curved Reaming System facilitates predictable anatomic tunnel placement in femoral ACL reconstruction allowing surgeons to achieve longer tunnels without the need for hyperflexing.

Cat. No.

GraftMax™ Curved Reaming, Medial Portal Approach

GraftMax™ Curved Guide.....	KS-CDG
GraftMax Indicator Arm	KS-IND
GraftMax Indicator Pin.....	KS-ACP
GraftMax Flex XACTPIN™.....	KS-FGP24
GraftMax Flex Channel Reamer, 4.5mm	KC8545
GraftMax Flex Channel Reamer, 5.0mm	KC8550
GraftMax Flex Sentinel™ Reamer, 5.5mm	KS8555
GraftMax Flex Sentinel Reamer, 6.0mm	KS8560
GraftMax Flex Sentinel Reamer, 6.5mm	KS8565
GraftMax Flex Sentinel Reamer, 7.0mm	KS8570
GraftMax Flex Sentinel Reamer, 7.5mm	KS8575
GraftMax Flex Sentinel Reamer, 8.0mm	KS8580
GraftMax Flex Sentinel Reamer, 8.5mm	KS8585
GraftMax Flex Sentinel Reamer, 9.0mm	KS8590
GraftMax Flex Sentinel Reamer, 9.5mm	KS8595
GraftMax Flex Sentinel Reamer, 10.0mm	KS8510
GraftMax Flex Sentinel Reamer, 10.5mm	KS85105
GraftMax Flex Sentinel Reamer, 11.0mm	KS8511
GraftMax Flex Sentinel Reamer, 12.0mm	KS8510
GraftMax Flex Sentinel Reamer, 13.0mm	KS8513

Femoral Instrumentation

» This instrumentation permits multiple surgical approaches to tunnel placement and graft fixation for ACL and PCL reconstruction procedures

Cat. No.

Transtibial Approach

Bullseye® Femoral Off-Set Guide, 5mm	C8650
Bullseye Femoral Off-Set Guide, 6mm.....	C8660
Bullseye Femoral Off-Set Guide, 7mm.....	C8670
Bullseye Femoral Off-Set Guide, 8mm.....	8680A

Medial Portal Approach

Bullseye Femoral Footprint Guide, 6mm	SB6000
Bullseye Femoral Footprint Guide, 7mm	SB7000
Bullseye Femoral Footprint Guide, 8mm	SB8000
Bullseye Femoral Footprint Guide, 9mm	SB9000
Bullseye Femoral Footprint Guide, 10mm	SB10000
Bullseye Femoral Footprint Guide, 11mm	SB11000

Outside-In Approach

Pinn-ACL® Femoral Guide, Right.....	8205
Pinn-ACL Femoral Guide, Left	8206
Femoral Guide Introducer	8207

Tibial Instrumentation

Pinn-ACL® Guide System

- » The Pinn-ACL® cruciate guide can be used to create tibial tunnels of known lengths with a variable angle adjustment of 35° to 60° and a graduated pin-sleeve
- » The Pinn-ACL cruciate guide and femoral guides have a patented collet locking mechanism that provides accurate pin placement using single-handed control

Cat. No.

ACL Guide

Pinn-ACL, Tibial Guide (includes ACL Guide Arm and Pin-sleeve)8731

ACL Tibial Guide

8mm Bullseye Tibial Footprint GuideDB8TAM

PCL System

PCL Guide Arm (for use with 8731)C8732

PCL Pin-SleeveC8728

PCL Guide Pin, Etched (5 per Box)C8729

ACL Disposable Kits

These ACL kits contain all of the disposable equipment needed to perform a complete ACL, at a savings over buying the individual components separately.

Anatomic Kit Includes:

- » XACTPIN® Graft Passing Guide Pin
- » 12" Hewson Break-Away Pin, 2.4mm dia.
- » 12" High-Strength Guide Pin, 2.4mm dia.
- » 18.5" Bioscrew® Hyperflex Guidewire, Nitinol, .045" dia.
- » 18.5" Hyperflex Guidewire, Nitinol, .062" dia.
- » Bone Tunnel Plug and Obturator
- » Surgical Marking Pen with Ruler

Anatomic ACL Disposable Kit8820

Universal Kit Includes:

- » Graft Passing Guide Pin
- » 12" Hewson Break-Away Pin, 2.4mm dia.
- » 12" High-Strength Guide Pin, 2.4mm dia.
- » 18.5" Bioscrew® Hyperflex Guidewire, Nitinol, .045" dia.
- » 18.5" Hyperflex Guidewire, Nitinol, .062" dia.
- » Bone Tunnel Plug and Obturator
- » Surgical Marking Pen with Ruler

Universal ACL Disposable Kit8821

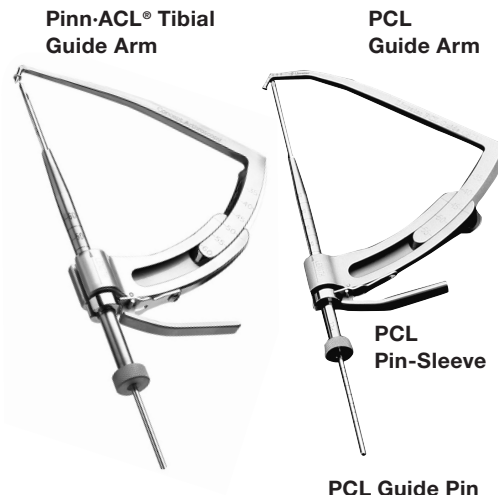

Anatomic ACL Disposable Kit



Universal ACL Disposable Kit

All products may not be available in all markets.



Bone Tunnel Plug

Bone Tunnel Plug

» The cannulated bone tunnel plug helps to control fluid loss while providing a sealed instrument portal.

Cat. No.

Bone Tunnel Plug w/Obturator..... C8778

Graft Passing Guide Pins

2 Pin Passer, Drill Tip C8623

2 Pin Passer, Trocar Tip..... 8623

Graft Passing Guide Pin, 2.4mm (.09375") dia. x 43.18cm (17")..... C8675S

ACTPIN® Graft Passing Guide Pin, 2.4mm (.09375") dia. x 43.18cm (17")..... C8677S

High-Strength Guide Pins

» Made of high-strength stainless steel for durability in drilling and to resist flexing

9" High-Strength Guide Pin, 2.4mm (.09375") dia. (5 per Box)9742D

12" High-Strength Guide Pin, 2.4mm (.09375") dia. (5 per Box)9745D

14" High-Strength Guide Pin, 2.4mm (.09375") dia. (5 per Box)9744D

Hewson Break-Away Pins

» Pre-scored guide pins are designed to break away to facilitate secondary guide pin placement

» Versatile drilling pin may be used with all drill guides having 2.4mm (.09375") dia. pin sleeves

9" Hewson Break-Away Pin, 2.4mm (.09375") dia. (5 per Box)..... 9743D



Magnetic Retriever

Magnetic Retriever

For recovery of ferrous metallic objects utilizing magnetic attraction

Magnetic Retriever.....9970



Bullseye Native Footprint Ruler

Accessories

Bullseye Native Footprint Ruler RL1000

Bullseye Femoral Guide, End Plug C8649

Parallel Pin Guide 8208

Tibial Pin Placement Guide.....9947

Aperture Chamfer.....8736

Wire Handler WH 100



Wire Handler

Replacement Accessories

ACL Pin-Sleeve (for use with 8731).....8719

ACL Pin-Sleeve (for use with 8205 and 8206).....8218

All products may not be available in all markets.

Osteoprep® Instruments

Osteoprep Instruments provide an array of bone shaping devices especially suited for notchplasties.

Microfracture awls allow the creation of localized vascular access channels in chondral defects. They are also useful in marking intended drill sites in all ACL and PCL procedures.

Curettes

	Cat. No.
Open Curette, 3mm.....	24.1005
Open Curette, 4mm.....	25.1005
Open Curette, 8mm.....	8211
Cupped Curette, 3mm.....	24.1006
Cupped Curette, 4mm.....	25.1006
Cupped Curette, 8mm.....	8212
PCL Curved Curette, 4mm.....	C8737

Rasps

Straight Rasp, 4mm.....	25.1007
Convex Rasp, 4mm.....	25.1637
Concave Rasp, 4mm.....	25.1647
Tunnel Rasp, Fine, 9mm.....	C8734
PCL Curved Rasp.....	C8736

Microfracture Awls

Microfracture Awl, 30°, 279mm length.....	8201
Microfracture Awl, 45°, Thin Shaft, 279mm length.....	8202
Microfracture Awl, 45°, Standard, 279mm length.....	8203
Microfracture Awl, 90°.....	8204
Microfracture Awl, 30°, 190.5mm length.....	7201
Microfracture Awl, 45°, 190.5mm length.....	7202
Microfracture Awl, 90°, 190.5mm length.....	7204

Osteotome

Graduated Osteotome, 6mm.....	8213
-------------------------------	------

Accessories

Instrument Tray with Lid (Accommodates 8 Osteoprep Instruments).....	8217
--	------



Open Curette



Closed Curette



Straight Rasp



Convex Rasp



Concave Rasp



Tunnel Rasp, fine



Graduated Osteotome



Microfracture Awl, 30°



Microfracture Awl, 45°,
Thin Shaft



Microfracture Awl, 90°



Microfracture Awl, 45°,
Standard



PCL Rasp



PCL Curette

All products may not be available in all markets.



Precision Probes

Unique handles give a firm grip and aid in instrument control. Shafts are hardened to resist breakage and tapered for better visualization. All straight probes have etched graduations in 5mm increments.

Probes available separately:

Cat. No.

4.0mm dia. Tip, Maxi-Probe, Straight, Green Handle	21.1002
3.5mm dia. Tip, Mini-Probe, Straight, Blue Handle	21.1001
Extended Length Depth Probe.....	21.100EL



Patellar Tendon Graft Guide System

- » Designed for systematic retrieval of patellar tendon grafts for ACL and PCL reconstruction procedures
- » Set of four templates accurately sizes graft sections from 9 to 12mm dia. to facilitate proper fit into bone tunnels
- » Precise cutting of both the tibial and patellar sections of graft is simplified
- » Concave bases on templates assure positive seating over the tibial tubercle

Graft Guide Templates

Graft Guide Template, 9mm	8720
Graft Guide Template, 10mm	8722
Graft Guide Template, 11mm.....	8724
Graft Guide Template, 12mm	8726

Accessories

Screw Drill Set (set includes:)	
One 2.4mm (.09375") x 2.5" Screw Drill One	
2.4mm (.09375") x 3.25" Screw Drill	8730
Sawblade with Stop, Hall® (Non-sterile, Single-use, 1 per Box).....	8703
Sawblade with Stop, 3M (Non-sterile, Single-use, 1 per Box).....	8706
Sawblade with Stop, Hall (Sterile, Single-use, 5 per Box).....	C8902
Sawblade with Stop, Hall MicroChoice® (Sterile, Single-use, 5 per Box).....	C8904
Sawblade with Stop, Stryker 2000 (Sterile, Single-use, 5 per Box).....	C8905

All products may not be available in all markets.

Parasmillie® Graft Harvester

The unique design of the Parasmillie® harvester makes it the highest quality one-pass harvester available.

Crescent-shaped blades ensure a full-depth cut in a single push, while atraumatic “feet” protect surrounding tissue during insertion and cutting. The feet follow the fiber contours of the tendon to harvest strong, whole fibers of a consistent depth and width.

The Parasmillie harvester is designed to push up rather than pull down, allowing the choice of a one-incision or smaller two-incision technique. Single-use blade tips easily slide on and lock. When you’re finished, pop the blade from the reusable handle with one easy push of a button.

	Cat. No.
Parasmillie Handle	C8900
Parasmillie Blade, 9mm (Sterile, Single-use, 5 per Box)	C8909
Parasmillie Blade, 10mm (Sterile, Single-use, 5 per Box)	C8910
Parasmillie Blade, 11mm (Sterile, Single-use, 5 per Box)	C8911



Parasmillie® Graft Harvester

Tendon Harvester

- » For safe retrieval of semitendinosus and gracilis tendons for ACL and PCL reconstruction procedures
- » Grafts of known lengths can be harvested while reducing the risk of muscle, tendon and other soft tissue trauma
- » May be used for blunt dissection in the proximal direction while the instrument is locked onto the tissue
- » Controlled cutting action cuts cleanly without tearing the tendon from the muscle insertion
- » Allows harvesting with or without resection of the tibial insertion point

Tendon Harvester	8750
------------------------	------



Tendon Harvester

All products may not be available in all markets.



Tendon Stripper



**SutureLoop™ Hi-Fi®
Suture Straight
Needle**

**SutureLoop Hi-Fi
Suture Curved
Needle**



Eccentric Guide

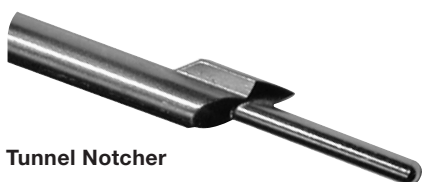

Tunnel Notcher

Tendon Stripper

- » For safe retrieval of semitendinosus and gracilis tendons for ACL and PCL reconstruction procedures
- » 7mm diameter opening allows for full thickness tendons to be harvested without damage to surrounding soft tissue
- » Closed design allows full, 360° enclosure for the tendon

Cat. No.

Tendon Stripper..... TS8850

Accessories

	Cat. No.	Cat. No.
Sizing Tube, 7mm.....	8737	Sizing Tube, 6.5mm8790
Sizing Tube, 8mm.....	8738	Sizing Tube, 7.5mm8791
Sizing Tube, 9mm.....	8739	Sizing Tube, 8.5mm8792
Sizing Tube, 10mm.....	8740	Sizing Tube, 9.5mm8793
Sizing Tube, 11mm.....	8741	Sizing Tube, 10.5mm8794
Sizing Tube, 13mm.....	8743	Sizing Tube, 12mm8742

SutureLoop™ Hi-Fi® Suture

- #2 Hi-Fi Suture, 60mm Straight Needle, 20" Loop (12 per Box)..... HL200
- #2 Hi-Fi Suture, 48mm Curved Needle, 20" Loop (12 per Box)..... HL201

Eccentric Guides and Tunnel Notcher

The eccentric guides are designed to complement an endoscopic ACL reconstruction technique by precisely positioning either a 2-pin passer or the tunnel notcher.

The tunnel notcher removes a 1.5mm deep pathway of cancellous bone adjacent to the femoral tunnel. This vacant pathway will enhance guidewire placement and facilitate easier screw insertion.

Instruments

Eccentric Guide, 8mm dia.....	C8108
Eccentric Guide, 9mm dia.....	C8109
Eccentric Guide, 10mm dia.....	C8110
Eccentric Guide, 11mm dia.....	C8111
Eccentric Guide, 12mm dia.....	C8112
Tunnel Notcher.....	C8106
Four Quadrant Tunnel Notcher.....	C8104

Concept® GraFix® Tunnel Dilator System

This fully modular system plays a key role during ACL and PCL surgeries, improving soft-tissue graft fixation within a femoral or tibial tunnel. By compacting cancellous bone within the femoral and tibial tunnels, the result is a higher pullout strength for soft-tissue grafts when used in conjunction with interference screws.

Features:

Dilators

Benefits:

- » Tapered ends allow for easy insertion and removal of the dilators from the femoral or tibial tunnel
- » Full radiused depth marks from 10mm to 40mm, in 5mm increments

T-Handle

- » Ergonomic styling allows for an easy grip and maneuverability
- » Built in locking quick connector, allows for easy intraoperative changing, as well as minimizing the potential for the units to separate during use
- » Fully cannulated to 2.45mm diameter

Slaphammer

- » Ensures that the forces delivered to the dilator will be applied inline with the guide pin, thereby eliminating divergence during dilation
- » Fully cannulated to allow the assembly to be placed over guide pins up to 2.45mm diameter

Cat. No.

Tunnel Dilator T-Handle.....	TD8501
Tunnel Dilator Slap-Hammer	TD8502
Tunnel Dilator Sterilization Case	TD8504
Tunnel Dilator, 6.0mm	TD8506
Tunnel Dilator, 6.5mm	TD8506.5
Tunnel Dilator, 7.0mm.....	TD8507
Tunnel Dilator, 7.5mm.....	TD8507.5
Tunnel Dilator, 8.0mm	TD8508
Tunnel Dilator, 8.5mm	TD8508.5
Tunnel Dilator, 9.0mm.....	TD8509
Tunnel Dilator, 9.5mm.....	TD8509.5
Tunnel Dilator, 10.0mm.....	TD8510
Tunnel Dilator, 10.5mm.....	TD8510.5
Tunnel Dilator, 11.0mm	TD8511
Tunnel Dilator, 11.5mm	TD8511.5
Tunnel Dilator, 12.0mm.....	TD8512

Graft Sizing Rings

Graft Sizing Ring, Large.....	GFT-LG
Graft Sizing Ring, Small	GFT-SM



Tunnel Dilator T-Handle



Tunnel Dilator Slap-Hammer



Tunnel Dilators

All products may not be available in all markets.

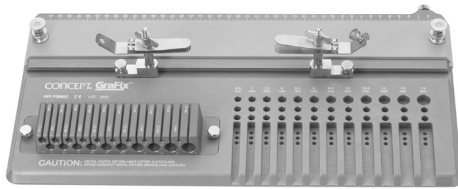

Graft Preparation Table, Scraping Board and Graft Sizing Block



Slide Lock

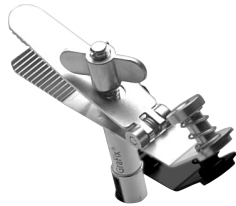

Soft Tissue Graft Clamp



Suture Holder Clamp

Tension Clamp



Bone-Tendon-Bone Clamp



Bone Block Drill Guide



2mm Twist Drill w/Stop

Concept® GraFix® Graft Preparation System

This fully modular system plays a key role during ACL and PCL reconstructive surgeries to prepare soft tissue and bone-tendon-bone autografts or allografts. The system allows the surgeon to interchange the various components to clean, whip stitch, measure, pre-tension, or add a fixation device.

The sizing block, sold separately, can accommodate grafts from 3.0mm to 13mm, in 0.5mm increments.

The universal slide locks allow for any of the graft preparation table components to be changed intraoperatively, easily and quickly. The slide locks are also fully adjustable via the spring loaded locking button, for one handed adjustments.

The Tension Clamp is etched in both Pounds (30 lbs. max) and Newtons (120 N max) for quick referencing during pre-tensioning of the graft for those surgeons who feel it is necessary for satisfactory post-op results.

The Graft Clamps are designed to act as an extra set of hands and incorporate atraumatic teeth to prevent damage to the graft.

	Cat. No.
Graft Preparation Table.....	PS8820
Slide Lock (2 Recommended).....	PS8821
Soft Tissue Graft Clamp.....	PS8822
Suture Holder Clamp	PS8823
Tension Clamp.....	PS8824
Bone-Tendon-Bone Clamp	PS8826
Bone Block Drill Guide	PS8829
Scraping Board.....	PS8830
Surgical Instrument Tray	PS8831
Graft Sizing Block, Grafix	PS8832
XO Button® Holder	PS8834
2mm Twist Drill w/Stop.....	8733

Graft Sizing Rings

Graft Sizing Ring, Large	GFT-LG
Graft Sizing Ring, Small	GFT-SM

All products may not be available in all markets.

ACL Sawblades: 12mm Depth Stop, for use with CONMED Patellar Tendon Graft Guide System

The following blades are equipped with a 12mm depth stop, and when used in conjunction with CONMED's Patellar Tendon Graft Guide System, provide an 8mm depth stop. This stop provides a means of cutting a consistent bone block for bone-tendon-bone cruciate reconstruction.

	Cat. No.
Sawblade with Stop, Hall® (Non-sterile Single-use, 1 per Box).....	8703
Works with the following Hall Handpieces: Micro100™ Sagittal Saw (5053-011)	
Sawblade with Stop, Stryker (Non-sterile Single-use, 1 per Box)	8704
Works with the Stryker Command System (Original Command System only; does not fit Command II System).	
Sawblade with Stop, 3M (Non-sterile Single-use, 1 per Box)	8706
Works with the Mini-Driver™	
Sawblade with Stop, Hall (Sterile, Single-use, 5 per Box)	C8902
Works with the following Hall Handpieces: Series 4® Oscillator, Micro100 Sagittal Saw (5053-011)	
Sawblade with Stop, Hall (Sterile, Single-use, 5 per Box)	C8904
Works with the following Hall Handpieces: Micro100 Sagittal Saw (5053-011), MicroChoice® Electric Powered Surgical System (5020-022)	
Sawblade with Stop, Stryker (Sterile, Single-use, 5 per Box)	C8905
Works with the Stryker 2000 Sagittal Saw.	

ACL Sawblades: 8mm Depth Stop, Freehand

The following blades are equipped with an 8mm depth stop. This stop provides a means of cutting consistent bone block for bone-tendon-bone cruciate reconstruction. Packaged sterile, single-use, 5 per box.

Free-Hand Sawblade, Hall.....	C8802
Works with the following Hall Handpieces: Versipower® Plus Oscillator (5071-002), Series 4® Oscillator (5067-002)	
Free-Hand Sawblade, Hall.....	C8803
Works with the following Hall Handpieces: Micro 100 Sagittal Saw (5053-011), Series 4 Oscillator (5067-002)	
Free-Hand Sawblade, Hall.....	C8804
Works with the following Hall Handpieces: Micro 100 Sagittal Saw (5053-011), MicroChoice Sagittal Saw (5020-022)	



8703



8704



8706



C8902



C8904



C8905



C8802



C8803



C8804

All products may not be available in all markets.



GraftMax™ Flex™ Sentinel Reamers

	Cat. No.
GraftMax™ Flex Sentinel™ Reamer, 5.5mm	KS8555
GraftMax Flex Sentinel Reamer, 6.0mm	KS8560
GraftMax Flex Sentinel Reamer, 6.5mm	KS8565
GraftMax Flex Sentinel Reamer, 7.0mm	KS8570
GraftMax Flex Sentinel Reamer, 7.5mm	KS8575
GraftMax Flex Sentinel Reamer, 8.0mm	KS8580
GraftMax Flex Sentinel Reamer, 8.5mm	KS8585
GraftMax Flex Sentinel Reamer, 9.0mm	KS8590
GraftMax Flex Sentinel Reamer, 9.5mm	KS8595
GraftMax Flex Sentinel Reamer, 10.0mm	KS8510
GraftMax Flex Sentinel Reamer, 10.5mm	KS85105
GraftMax Flex Sentinel Reamer, 11.0mm	KS8511
GraftMax Flex Sentinel Reamer, 12.0mm	KS8512
GraftMax Flex Sentinel Reamer, 13.0mm	KS8513

All products may not be available in all markets.

Sentinel® Drill Bits

The eccentric, mono-fluted cutting edge is designed to facilitate ligament reconstruction procedures requiring more anatomic tunnel placement. Protects cartilage and soft tissue when drilling femoral tunnels during ACL reconstruction procedures.

- » Supports most minimally invasive techniques to produce a more anatomical femoral graft placement
- » For use in both transtibial or anteromedial portal techniques for femoral and tibial tunnel drilling
- » Avoids damage to PCL or cartilage
- » Allows for smaller skin incisions

	Cat. No.
5.5mm dia.	S8555
6.0mm dia.	S8560
6.5mm dia.	S8565
7.0mm dia.	S8570
7.5mm dia.	S8575
8.0mm dia.	S8580
8.5mm dia.	S8585
9.0mm dia.	S8590
9.5mm dia.	S8595
10mm dia.	S8510
10.5mm dia.	S85105
11mm dia.	S8511
11.5mm dia.	S85115
12mm dia.	S8512
12.5mm dia.	S85125
13mm dia.	S8513

Packaged sterile, single-use.



All products may not be available in all markets.



Badger® Drill Bits

- » Tapered head is suited for an endoscopic ACL technique whereby the femoral tunnel is reamed from inside-out while minimizing the risk of injury to the PCL
- » Drill bit shaft is etched in 15-120mm depth marks for easy identification of tunnel depth
- » 9" length facilitates open femoral tunnel preparation and in-line tunnel reaming for endosteal fixation procedures
- » Head profile permits easy withdrawal from bone tunnels

	Cat. No.
5.0mm dia.	C8550
5.5mm dia.	C8591
6.0mm dia.	C8592
6.5mm dia.	C8593
7.0mm dia.	C8582
7.5mm dia.8593
8.0mm dia.	C8599
8.5mm dia.	C8583
9.0mm dia.	C8692
9.5mm dia.	C8584
10.0mm dia.8594
10.5mm dia.	C8585
11.0mm dia.8595
12.0mm dia.8596
13.0mm dia.8597

Packaged sterile, limited reuse, 4 per box.

GraFix® Coring Reamer System

The CONMED GraFix® Coring Reamer System uses a unique centering bushing to allow reaming of a tibial tunnel for cruciate reconstruction while harvesting a core of bone. The harvested core of bone can be used to fill defect sites, combined to create a composite BTB graft, fill in space in the tibial tunnel, and fill in large tunnels in cruciate revision surgery.

- » Depth markings provide external visual depth of reamer on the tibia (10-50mm)
- » The unique packaging that includes a collection tube guarantees proper collection of the harvested bone core when used with the Coring Reamer Plunger
- » The quick connect adapter fits Zimmer attachments for easy, quick connection to power equipment. Also has a Jacob's Chuck connection
- » The Wrench provides an easy means of removing the Reamer from the adapter

	Cat. No.
7mm Coring Reamer/Bushing (Sterile, 4 per Box)	CR8847
8mm Coring Reamer/Bushing (Sterile, 4 per Box)	CR8848
9mm Coring Reamer/Bushing (Sterile, 4 per Box)	CR8849
10mm Coring Reamer/Bushing (Sterile, 4 per Box)	CR8850
11mm Coring Reamer/Bushing (Sterile, 4 per Box)	CR8851
Coring Reamer Plunger (Non-sterile)	CR8900
Coring Reamer Adapter (Non-sterile)	CR8901
Coring Reamer T-Wrench (Non-sterile)	CR8902

Long Head C-Reamer™

- » End-cutting head design produces accurate sizing of bone tunnels for ACL and PCL reconstruction procedures
- » Sharp cutting edges minimize heat-related bone necrosis
- » Tapered trailing edges aid in removal from the joint

6mm dia., Long Head	8786
7mm dia., Long Head	8787
8mm dia., Long Head	8788

Short Head Cannulated C-Reamer™

- » End-cutting head design produces accurate sizing of bone tunnels for ACL and PCL reconstruction procedures
- » Sharp cutting edges minimize heat-related bone necrosis
- » Cannulated reamer shaft is etched in 15 – 70mm depth marks for easy identification of tunnel depth
- » Tapered trailing edges aid in removal from the joint

9mm dia., Short Head	8772A
10mm dia., Short Head	8773A
11mm dia., Short Head	8774A
12mm dia., Short Head	8775A

Packaged sterile, single-use, 4 per box.

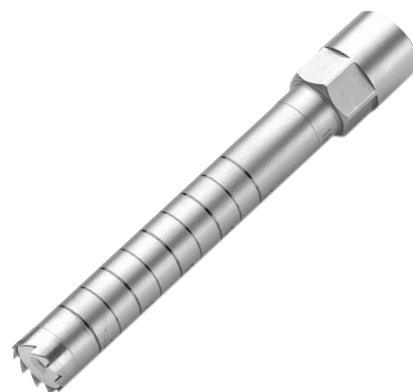

Coring Reamer T-Wrench

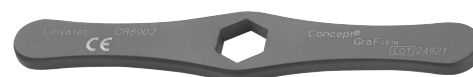

Coring Reamer Adapter

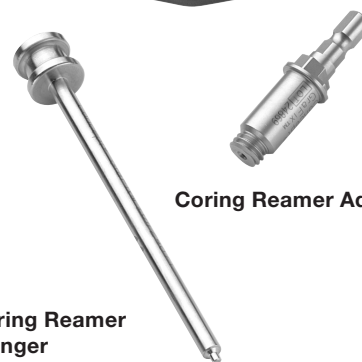

Coring Reamer Plunger



**(Long Head)
6mm-8mm**

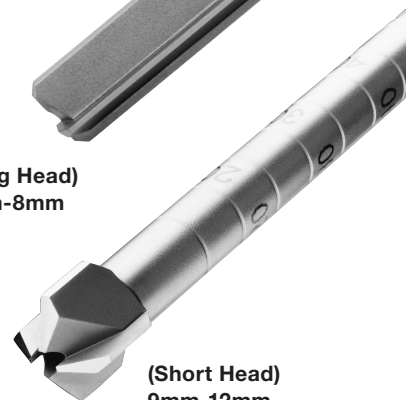

**(Short Head)
9mm-12mm**

All products may not be available in all markets.

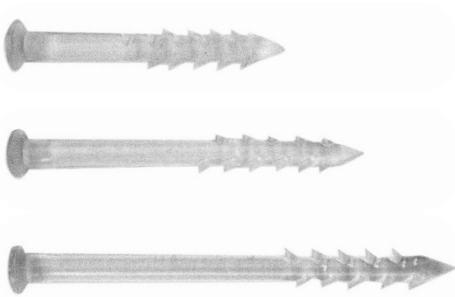
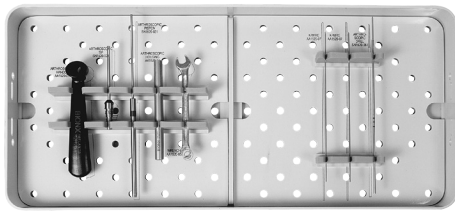

1.5mm Percutaneous Tip



Housing

Handle

1.5 Percutaneous Piston

1.5 Percutaneous Drill Bit

The SmartNail® OCD Repair

The SmartNail® bio-absorbable Bone Fixation Nail is indicated for use in the fixation of fragments of fractured non-load bearing bones, osteotomies and arthrodeses, for example in the fixation of apical fragments, osteochondral fragments and cancellous/non-load bearing fragments. The SmartNail implant is constructed of Self-Reinforced 96L/4D PLA copolymer material, which allows secure fixation in combination with suitable immobilization. The SmartNail implant loses its strength during 20–50 weeks in vivo, which is within a corresponding period of time for a fracture of bone to heal. The SmartNail implant biodegrades in bone tissue during approximately 2–3 years in vivo. This eliminates the need for a second operation to remove nonabsorbable fixation devices after the healing of the fracture. The SmartNail implant is sterile, inert and non-collagenous.

Cat. No.

Implants

SmartNail (96L/4D) PLA, 1.5mm Outer Diameter (O.D.) x 16mm L.....	531516
SmartNail (96L/4D) PLA, 1.5mm O.D. x 20mm L.....	531520
SmartNail (96L/4D) PLA, 1.5mm O.D. x 25mm L.....	531525
SmartNail (96L/4D) PLA, 2.4mm O.D. x 16mm L.....	532416
SmartNail (96L/4D) PLA, 2.4mm O.D. x 25mm L.....	532425
SmartNail (96L/4D) PLA, 2.4mm O.D. x 35mm L.....	532435
SmartNail (96L/4D) PLA, 2.4mm O.D. x 45mm L.....	532445

General Instruments

Handle	AA1520-01
Housing.....	AA1520-04
Wrench	AA1520-05
K-Wire (2 each)	AA1520-07

1.5mm Set

1.5mm Arthroscopic Tip (Green)	AT1500
1.5mm Arthroscopic Piston	AP1500
1.5mm Arthroscopic Drill Bit.....	DB1500
1.5mm Percutaneous Tip (Blue).....	SN1520-021
1.5 Percutaneous Piston	SN1520-031
1.5 Percutaneous Drill Bit.....	SN1520-061

2.4mm Set

2.4mm Arthroscopic Tip (Yellow).....	AT2400
2.4mm Arthroscopic Piston	AP2400
2.4mm Arthroscopic Drill Bit.....	DB2400
2.4mm Percutaneous Tip (Red).....	PT2400
2.4mm Percutaneous Piston	PP2400
2.4mm Percutaneous Drill Bit.....	DB2401

Sterilization Tray

Sterilization Tray (New Plates)	ST1007
Sterilization Plate 2 (Other Instruments).....	STP1524

All products may not be available in all markets.

Sequent™ Meniscal Repair Device

The Sequent™ Meniscal Repair Device is an All-Inside, Stay-Inside continuous stitching system that allows surgeons to complete the repair of virtually any meniscal tear using only one device without having to leave the joint.

- » Create up to 6 continuous stitches
- » Loaded with PEEK Optima Implants
- » Variable depth stop sheath and entry cannula

	Cat. No.
Sequent Meniscal Repair Device, Curved Needle, 7 Implants.....	MR007C
Sequent Meniscal Repair Device, Curved Needle, 4 Implants	MR004C
Sequent Meniscal Repair Device, Curved Needle, 3 Implants	MR003C
Sequent Disposable Kit (Suture Cutter, Entry Cannula).....	SCEC047
Sequent Disposable Suture Cutter.....	SC047D
Sequent Reusable Entry Cannula.....	EC047

Contour™ Meniscus Arrow™

The Contour Meniscus Arrow is indicated for the repair of vertical, longitudinal “Bucket-Handle” tears of the meniscus in the vascular zone (red-red, red-white) through arthroscopic and open methods. The Arrow consists of a low profile rounded head, which will sit just below the surface of the meniscus while compressing the tear. The Contour Meniscus Arrow contains barbs along the entire length of the implant shaft for superior fixation strength.

The Arrows implants are made of a proprietary Self-Reinforced copolymer, 80L/20D,L PLA, which imparts to the implants an ultra-high strength microstructure that has a unique ability to resist shear and torque while the tear is healing. The new 80L/20D,L PLA copolymer is a faster resorbing implant material that will continue to provide strength for up to 24 weeks while the tear is remodeling and then gradually resorb away.

Single Implant Packaging

Contour Meniscus Arrow 80L/20D,L PLA ,	541110
1.1mm O.D. x 10mm L, 1 Pkg	
Contour Meniscus Arrow 80L/20D,L PLA,	541113
1.1mm O.D. x 13mm L, 1 Pkg	
Contour Meniscus Arrow 80L/20D,L PLA ,	541116
1.1mm O.D. x 16mm L, 1 Pkg	

Pre-Loaded Implants for CrossBow® Inserter

Contour Meniscus Arrow 80L/20D,L PLA,	541110-1
1.1mm O.D. x 10mm L, 1 Pkg (Pre-Loaded for CrossBow®)	
Contour Meniscus Arrow 80L/20D,L PLA,	541110-3
1.1mm O.D. x 10mm L, 3 Pkg (Pre-Loaded for CrossBow)	
Contour Meniscus Arrow 80L/20D,L PLA,	541113-1
1.1mm O.D. x 13mm L, 1 Pkg (Pre-Loaded for CrossBow)	
Contour Meniscus Arrow 80L/20D,L PLA,	541113-3
1.1mm O.D. x 13mm L, 3 Pkg (Pre-Loaded for CrossBow)	
Contour Meniscus Arrow 80L/20D,L PLA,	541116-1
1.1mm O.D. x 16mm L, 1 Pkg (Pre-Loaded for CrossBow)	



Sequent™ Meniscal Repair Device

Sequent Disposable Suture Cutter

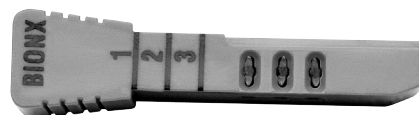

Contour Meniscus Arrows are also available in preloaded single-use cartridges for easier handling in the operating room.

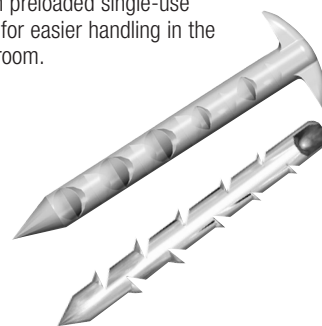

All products may not be available in all markets.



The CrossBow®

The CrossBow® Contour Meniscus Arrow Inserter allows the repair of vertical, longitudinal meniscus tears with the Meniscus Arrow without manual insertion and pre-forming a hole. By eliminating pre-forming a hole in the meniscus, the Meniscus Arrow pull-out strengths at time zero are increased 30 – 50% over our manual sets. The CrossBow inserts the Meniscus Arrow by a spring-loaded obturator with the pull of a trigger. The set includes a reusable stainless steel magazine which can hold up to four arrows of any length. The CrossBow can also be used with the preloaded, disposable magazines. Five area-specific cannulas are provided for easy access to the meniscus lesion.



**CrossBow®
Housing**

**CrossBow® Cannula
Left Curve**

**CrossBow Cannula
Right Curve**

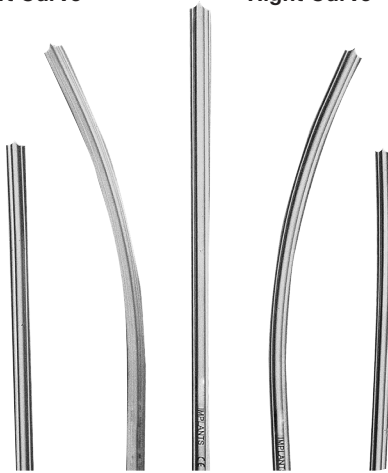

**CrossBow Cannula
Curved Tip**

**CrossBow Cannula
Curved Shaft**



Arthroscopic Probe

	Cat. No.
Arthroscopic Probe (Gold).....	AP1000
CrossBow Housing.....	MAC1100-01
CrossBow Magazine.....	MAC1100-02
CrossBow Cannula Right Curve	MAC1100-06
CrossBow Cannula Left Curve	MAC1100-07
CrossBow Cannula Curved Tip.....	MAC1100-08
CrossBow Cannula Curved Shaft.....	MAC1100-09
CrossBow Sterilization Tray.....	MAC0001

All products may not be available in all markets.

Contour™ Meniscus Arrow™ Manual Instrument Set

The specially designed Meniscus Arrow™ Manual Instrument Set (without channels) provides excellent tactile feedback when repairing vertical, longitudinal meniscus tears through arthroscopic methods. Five area-specific cannulas provide easy access to the tear site. Each cannula tip has teeth that are sloped to securely hold onto the meniscus surface when placing the Meniscus Arrow. Repair procedure O.R. times with the Meniscus Arrow are reduced by up to 50% over conventional inside-out horizontal suturing techniques.

	Cat. No.
Arthroscopic Probe (Gold).....	AP1000
Manual Needle (Meniscus Arrow).....	MA1100-01
Manual Obturator/Manual Piston.....	MA1100-021
Manual Cannula Straight.....	MA1100-05
W/Channel and Stylet	
Manual Cannula Right Curve.....	MA1100-06
Manual Cannula Left Curve.....	MA1100-07
Manual Cannula Curved Tip.....	MA1100-08
Manual Cannula Curved Shaft.....	MA1100-09

Accessories

Manual Stylet (Stabilizing Wire).....	MA1100-051
Replacement for MA1100-05	

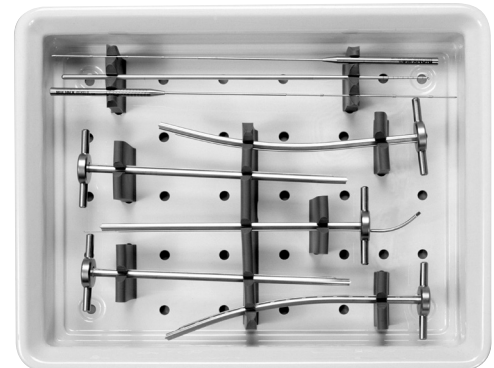

Arthroscopic Probe



Manual Needle



Manual Obturator/Manual Piston



Manual Cannula Curved Shaft



Manual Cannula Right Curve



Manual Cannula Left Curve



Manual Cannula Curved Tip

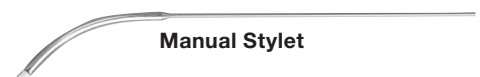

Manual Stylet

All products may not be available in all markets.

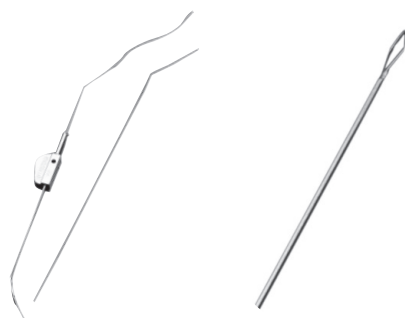

Double-Arm Needles **Needle with eyelet**



30° Rasp, Top Serrations



30° Rasp, Bottom Serrations



30° Rasp, Top/Bottom Serrations



90° Rasp, Top/Bottom Serrations



Mixing and Delivery Kit

Zone Specific® II Meniscal Repair System

- » A complete system of cannulas, needles and rasps specifically designed for inside-out meniscal repair procedures.
- » Six pre-bent cannulas provide optimum access to all zones of the meniscus. Funnel ends make loading of needles safe and easy, and fluid venting ports direct fluid away from the surgeon.
- » Double-Arm meniscal repair needles are made of stainless steel, and are ultra-thin and strong, yet flexible for easy passage. There are options for either #2/0 polyester or Hi-Fi® Suture conveniently pre-attached.
- » Meniscal repair needles are made of flexible nitinol, and have a large eyelet at one end to permit easy threading of suture material.
- » Four styles of meniscal rasps promote vascularity of meniscal tissue prior to suturing, with minimal risk to articulating surfaces.

Zone Specific® II Cannulas

	Cat. No.
Right Anterior.....	8532
Right Middle.....	8539
Right Posterior.....	8530
Left Anterior.....	8533
Left Middle.....	8540
Left Posterior.....	8531

Accessories

Meniscal Repair Needles (Nitinol, 10 per Box, Sterile).....	8570
Double-Arm Meniscal Repair Needles, Hi-Fi Suture (Stainless Steel, 10 per Box, Sterile).....	8536

Zone Specific® (Original Set)

Protective Cap Set (6/Set).....	8557
---------------------------------	------

Meniscal Rasps

30° Top Serrations.....	C8542.1
30° Bottom Serrations.....	C8541.1
30° Top and Bottom Serrations.....	C8537.1
90° Top and Bottom Serrations.....	C8536.1

Repair needles are packaged sterile, single-use.

Mixing Kits

CONMED Mixing and Delivery Kit

- » This kit is used to mix allograft, autograft, or synthetic bone graft materials.

	Cat. No.
Mixing and Delivery Kit.....	901201

CONMED Instrument Organization and Sterilization System

CONMED now offers a customizable instrumentation set for ACL procedures. The Sterilization Container houses up to three insert trays, each of which is designed to hold the tools you need to successfully complete the ACL reconstruction and any associated procedures.

Sterilization Container

CONMED Sterilization Container, ¾ size, 8 inch height..... **Cat. No.** INST-C348

Sterilization Trays

ACL Femoral Instruments Insert Tray.....INST-ACL01
 ACL Tibial Instruments Insert Tray.....INST-ACL02
 ACL Accessories Instruments Insert Tray.....INST-ACL03

Accessories

Aesculap Single Use Filter (US Only), qty 1000.....US994
 Aesculap Process Indicator Card (US Only), qty 250.....MD346
 Aesculap Tamper Evident Lock, blue, qty 1000.....US900
 Aesculap Filter Retainer Replacement Part.....JK100

Instrument Trays

Tunnel Dilator Tray..... **Cat. No.** TD8504
 Grafix® Graft Tray.....PS8831
 Anatomic Ligament Reconstruction Tray.....DBSBACL

CONMED Sterilization Container w/ ACL Femoral Instruments Insert Tray



ACL Tibial Instruments Insert Tray

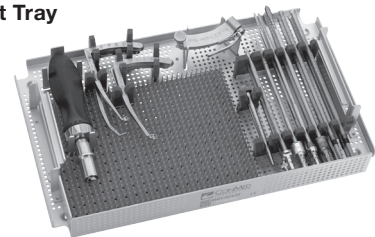

ACL Accessories Instruments Insert Tray

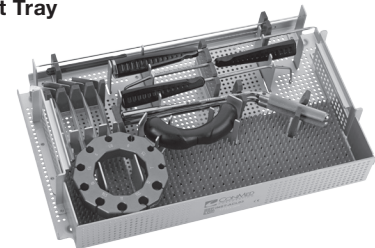

Anatomic Ligament Reconstruction Tray

All products may not be available in all markets.



**AssistArm™
Limb Positioner**

AssistArm™ Limb Positioner

The AssistArm Limb Positioner assures smooth, effortless and stable limb placement so the surgical team can focus on the procedure, not on holding the limb steady. The AssistArm is powered by hydraulic fluid and does not require electric, batteries or compressed air. The AssistArm can be used to position the shoulder in beach chair or lateral decubitus, knee and ankle for open or arthroscopic procedures.

Positioner

Cat. No.

AssistArm Limb Positioner AA-PSN100

Attachments

Arm Support for Beach Chair AA-AS-BC200
 Connector AA-CON250
 Traction Unit AA-TRAC400
 Arm Support for Lateral Decubitus AA-AS-LD500
 Knee AA-K600
 Ankle AA-A700

Disposable Kits

Disposable Kit for Shoulder and Knee, Packaged Sterile, 10/Box AA-SK-KIT10
 Disposable Kit for Ankle, Packaged Sterile, 10/Box AA-A-KIT10

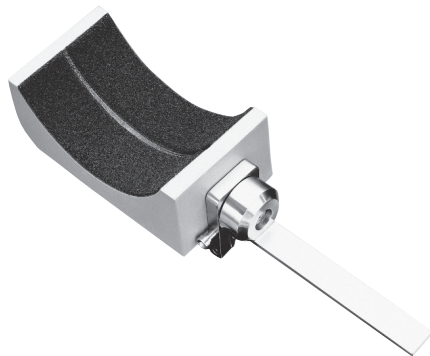

Shutt® Universal Stress Post

- » Break-away design allows use of “figure 4” position for meniscal repair procedures.
- » Velcro insert grips tourniquet.
- » Foam inserts minimize patient trauma.

Shutt Universal Stress Post RT.0010
 Replacement Foam Insert NS.0011

Zimmer Mason Leg Holder

Replacement Foam Pad (10 per Box) 60-3950-071

All products may not be available in all markets.

HIP ARTHROSCOPY PRODUCTS

All products may not be available in all markets.

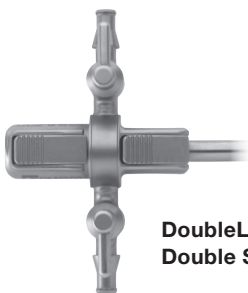

DoubleLatch® Hip Double Stopcock



DoubleLatch Hip Cannula Straight



DoubleLatch Hip Cannula Fenestrated



DoubleLatch Hip Conical Obturator

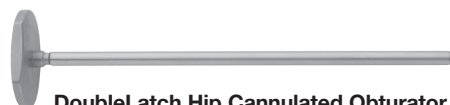

DoubleLatch Hip Cannulated Obturator



Seal Cap



Portal Dilator, Large 6.0mm



Disposable Banana Blade with Universal Blade Handle



Cannulated Obturator

DoubleLatch® Bridge System

- » Quick-to-connect system offers durability and enhanced ergonomics
- » Custom quick latch handles have been engineered for optimal hip joint insertion
- » Simplified portal transfer with the DoubleLatch Bridge attachment
- » Quicklatch® family of HD scopes provide excellent image quality and ease of use

	Cat. No.
Single Stopcock Doublelatch Hip Bridge	DLH100
Double Stopcock Doublelatch Hip Bridge	DLH200
Double Stopcock Doublelatch Reverse Hip Bridge	DLH202
5.8mm DoubleLatch Hip Conical Obturator	DLH580
5.8mm DoubleLatch Hip Cannulated Obturator	DLH581
4.6mm DoubleLatch Hip Conical Obturator	DLH460
4.6mm DoubleLatch Hip Cannulated Obturator	DLH461
5.8mm DoubleLatch Hip Cannula Straight	DLH582
5.8mm DoubleLatch Hip Cannula Fenestrated	DLH583
4.6mm DoubleLatch Hip Cannula Straight	DLH462
4.6mm DoubleLatch Hip Cannula Fenestrated	DLH463
Replacement Seals	DL1008
Replacement Cannula seal cap	DL1009
Seal Cap Installation and Removal Tool	DL1010
4.6mm DoubleLatch Hip Cannulated Obturator w/ Handle	HPS-H46
5.8mm DoubleLatch Hip Cannulated Obturator w/ Handle	HPS-H58

Portal Dilators

- » Three available sizes provide maximum access precision and flexibility

Portal Dilator, Small 4.6mm	HPS-PDS
Portal Dilator, Medium 5.2mm	HPS-PDM
Portal Dilator, Large 6.0mm	HPS-PDL

Hip Accessories and Procedure Accessories

- » Specifically engineered for hip arthroscopy, these products will assist you through joint entry and other key procedure steps

Switching StickPack®, 2 Switching Sticks, 2 Guidewires	HPS-SSP
Hip Access Needle Pack, 2/Pk	HPS-NDL
Disposable Banana Blade	HPS-BLD
Arthroscopy Cannula, 6/Box	HPS-CAN
Universal Blade Handle	HPS-BHNDL
Cannulated Obturator	9837

Disposable Kit

Provides the surgeon with all the disposable instruments needed for access to the hip joint. Includes distention needle, 2 guidewires, cannulated switching stick and 2 (8.0 x 120mm) Hex Flex® cannulas, as well as a banana blade and a syringe.

	Cat. No.
Disposable Kit	HA-222DK
Disposable Kit Brochure.....	CBR 8001

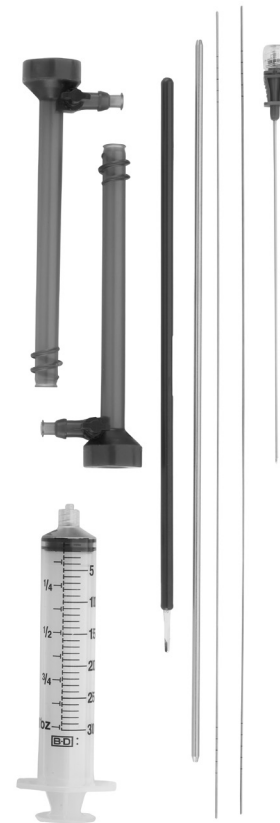

Slotted Cannulas

- » Low-profile design allows for the ease of instrument insertion and portal transfer
- » Differentiated, rigid uni-body shaft is constructed from a single piece of metal for a durable and reliable joint access solution

5mm Low Profile Slotted Cannula	HPS-SC5
6.7mm Low Profile Slotted Cannula.....	HPS-SC67
5mm Slotted Cannula	SC6900
6.7mm Slotted Cannula	SC7900



All products may not be available in all markets.

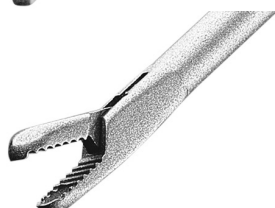

Shutt® Series 210® Manual Instruments

Wide range of tips (forceps, aggressors, scissors, suture retrievers) available. Shutt® 210's are 210mm in length and 3.4mm in diameter permitting access to the deep hip joint.

- » Quality and durability is the Shutt assurance
- » Engineered hinge pin breaks before any failure that could lead to metal being left behind in the joint

Cat. No.

90° Rotary Forceps

Blunt Tip Left S210RFL
Blunt Tip Right..... S210RFR

Aggressor Forceps

15° Up S210AFU
Left S210AFL
Right..... S210AFR

Retrograde Forceps

15° Up Right Bite S210RGF

Suture Retrieval Forceps

Straight..... S210SRF

Micro-Scissors

Straight..... S210MSC

Grasping Forceps

Straight W/Ratchet S210GSP

All products may not be available in all markets.

Signature Series™ Blades and Burs

- » Longer, stronger and designed exclusively for the hip joint
- » Available in pre-bent and straight styles
- » Unique curved bur designed to reach around femoral neck for more precise resection
- » All Blades and Burs have a 19cm working length. Blades run at 2,500rpm oscillate and 6,000rpm max and burs run at 12,000rpm max, 1 per box.
- » Blades and burs allow for resection of soft tissue and bone in deep, narrow joint spaces such as the hip.
- » Patented XtraSharp™ technology
- » Merlin® bendable technology
- » Concave and convex window configurations

	Cat. No.
4.2mm HPS Great White®, Prebent Convex.....	HPS-CB01
4.2mm HPS Great White, Prebent Concave.....	HPS-CB02
4.2mm HPS FRR, Prebent Convex.....	HPS-CB03
4.2mm HPS FRR, Prebent Concave.....	HPS-CB04
4.2mm HPS Gator®, Prebent Convex.....	HPS-CB05
4.2mm HPS Gator, Prebent Concave.....	HPS-CB06
4.2mm HPS Ultracut®, Prebent Convex.....	HPS-CB07
4.2mm HPS Ultracut, Prebent Concave.....	HPS-CB08
4.5mm EL Hip Prebent Spherical Bur.....	HPS-HB01
4.5mm EL Hip Prebent Polishing Bur.....	HPS-HB02
4.0mm EL Hip Prebent Oval Bur.....	HPS-HB03
5.5mm EL Hip Prebent Spherical Bur.....	HPS-HB11
5.5mm EL Hip Prebent Polishing Bur.....	HPS-HB12
6.0mm EL Hip Prebent Oval Bur.....	HPS-HB13
4.2mm HPS Great White, Sterling.....	HPS-C001
4.2mm HPS Gator, Sterling.....	HPS-C002
4.2mm HPS FRR, Sterling.....	HPS-C003
4.2mm HPS Ultracut, Sterling.....	HPS-C004
4.5mm HPS Spherical Bur.....	HPS-H001
4.0mm HPS Oval Bur.....	HPS-H002
4.0mm HPS Pear Bur.....	HPS-H003
4.5mm HPS Polishing Bur.....	HPS-H004
4.5mm HPS Vortex® Bur.....	HPS-H005
5.5mm HPS Spherical Bur.....	HPS-H011
6.0mm HPS Oval Bur.....	HPS-H012
6.0mm HPS Pear Bur.....	HPS-H013
5.5mm HPS Polishing Bur.....	HPS-H014
6.0mm HPS Vortex Bur.....	HPS-H015
4.0/4.5mm EL Bur Sheath.....	HPS-S001
5.5/6.0mm EL Bur Sheath.....	HPS-S011
4.2mm, Sterling, Shaver, Ultracut.....	EL9405
4.2mm, Merlin, Shaver, Cuda®, Bendable to 30°.....	EL9356
4.0mm, Sterling, Bur, Oval.....	EL9101
6.0mm, Sterling, Bur, Oval, 20° Reduced Hood.....	60VAL-EL-RH
4.2mm, Sterling, Shaver, Great White.....	EL9299
4.2mm, Sterling, Shaver, Great White, Pre-Bent 15°, Convex.....	EL9299D
4.2mm, Sterling, Shaver, Great White, Pre-Bent 15°, Concave.....	EL9299U
4.2mm, Sterling, Shaver, Gator.....	EL9263A
5.5mm, Sterling, Shaver, Gator.....	EL9260A
4.2mm, Sterling, Shaver, Full-Radius Resector, Pre-Bent 15°, Convex.....	EL9247D
4.2mm, Sterling, Shaver, Full-Radius Resector, Pre-Bent 15°, Concave.....	EL9247U
4.5mm, Sterling, Bur, Spherical, 20° Reduced Hood.....	EL9111RH
5.5mm, Sterling, Bur, Spherical, 20° Reduced Hood.....	55SPH-EL-RH



Oval Bur



Polishing Bur



Spherical Bur

All products may not be available in all markets.



Extended Length Katana® Suture Cutter



Extended Length Knot Pusher



Extended Length Liberator™ Knife



Extended Length Crochet Hook



Extended Length Depth Probe



0 Degree Light



30 Degree Light

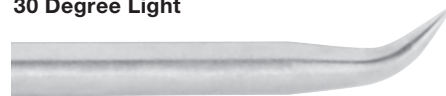

45 Degree Light



60 Degree



90 Degree Light



0 Degree Heavy



30 Degree Heavy



45 Degree Heavy



90 Degree Heavy



Curette, 45 Degree Heavy

Hip Manual Instruments

	Cat. No.
Cupped Curette, Hip	HPS-CC
Open Curette, Hip.....	HPS-OC
Extended Length Katana® Suture Cutter.....	GU1009EL
Extended Length Knot Pusher	8748EL
Extended Length Liberator™ Knife.....	25.50014EL
Extended Length Crochet Hook.....	C6105EL
Extended Length Depth Probe.....	21.1001EL

Microfracture Awl Instrumentation

The Microfracture Instrumentation Set includes the instruments necessary for chondral resurfacing and debridement.

- » Extended working length (340mm) for use in both hip and knee
- » Available in both “Light” and “Heavy” Configuration
- » Heavy configurations have strike plate and 3mm depth markings
- » 0, 30, 45, 60 and 90 degree tip angles
- » Curette and angled awl

0 Degree Light	MFX-0LT
30 Degree Light	MFX-30LT
45 Degree Light	MFX-45LT
60 Degree Microfracture Awl, Hip	HPS-60MF
90 Degree Light	MFX-90LT
0 Degree Heavy.....	MFX-0HV
30 Degree Heavy.....	MFX-30HV
45 Degree Heavy.....	MFX-45HV
90 Degree Heavy.....	MFX-90HV
Angled, 30 Degree Heavy	MFX-30ANG
Curette, 45 Degree Heavy.....	MFX-45CU
Sterilization Tray	MFX-TRAY

All products may not be available in all markets.

Spectrum® MVP™ Suture Passer

» Low profile 1.8mm suture hook the Spectrum MVP suture passer effectively passes and retrieves suture while preserving labral tissue

	Cat. No.
Spectrum MVP, Medium Crecent Hook, Extended Length, Disposable, Packaged Sterile, 3 per Box	C6400EL
Spectrum MVP, 45° Right Hook, Extended Length, Disposable, Packaged Sterile, 3 per Box	C6410EL
Spectrum MVP, 45° Left Hook, Extended Length, Disposable, Packaged Sterile, 3 per Box	C6420EL

Raven™

Extended Length Raven Straight	GU1004EL
Extended Length Raven 35° Up	GU1008EL



Spectrum MVP, Medium Crecent Hook



Spectrum MVP, 45° Right Hook

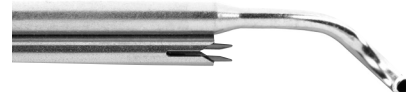

Spectrum MVP, 45° Left Hook



Extended Length Raven Straight



Extended Length Raven 35° Up

All products may not be available in all markets.



Poplok® Knotless Suture Anchor



PressFT™ Anchor



Drill Guide



Drill Guide, Offset



Bio Mini Revo®

Bio Instability Self-Drilling Bone Tap



Instability Drill Guide, Serrated



Instability Drill Guide, Fishmouth

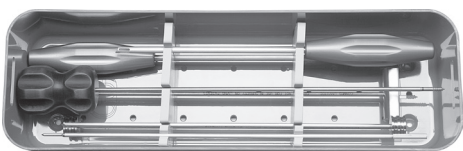

Bio Instability Surgical Instrument Tray

Poplok® Knotless Suture Anchor

- » Unique suture locking mechanism traps suture within the anchor, resulting in dependable fixation independent of bone quality
- » Ability to tension suture after anchor is seated

Cat. No.

Poplok 2.8mm w/One Strand of #2 Hi-Fi® Suture.....	GKP-2801
Poplok 2.8mm w/Two Strand of #0 Hi-Fi Suture.....	GKP-2802
Poplok 3.3mm w/One Strand of #2 Hi-Fi Suture.....	GKP-3301
Poplok 3.3mm w/Two Strand of #0 Hi-Fi Suture.....	GKP-3302
Poplok 2.8/3.3mm Drill Bit	BKL-00M
Poplok Guide	BGU-00M
Poplok Cannulated Obturator.....	BTR-HIP

PressFT™ Anchor

- » Smallest press-fit PEEK anchor for use in hip arthroscopy

PressFT 2.1 w/One Strand of #2(5 metric) Hi-Fi Suture	NP211H
PressFT 2.6 w/One Strand of #2(5 metric) Hi-Fi Suture	NP261H
PressFT Drill Bit 2.1.....	NDB21H
PressFT Drill Bit 2.6	NDB26H
PressFT Drill Guide.....	NDGH
PressFT Drill Guide, Offset.....	NDGHB
PressFT Cannulated Obturator	NCOH

Bio Mini Revo® Hip Instability Repair System

- » 3.1mm diameter thread-in style implant
- » Manufactured from patented Self-Reinforced 96L/4D PLA
- » High pull-out strength and ideal bioabsorbable characteristics
- » Low profile instrument set, including self-drilling tap, provide precise placement for the pilot hole and the implant for a reproducible technique
- » Proven screw-in design ensures optimal purchase in bone
- » Pre-threaded with #2 Hi-Fi Suture

Bio Mini Revo, Pre-threaded with #2 Hi-Fi Suture, Disposable Driver, 3.1mm O.D. x 11mm L.....	C6170HP
---	---------

Bio Instability Instrument Set

Extended Length Bio Instability Drill Guide, Fishmouth	C6171EL
Extended Length Bio Instability Drill Guide, Serrated	C6172EL
Blunt Obturator.....	C6173
Sharp Trocar	C6174
Bio Instability Twist Drill Bit, 2.1mm.....	C6179
Bio Instability Bone Punch, 2.1mm	C6176
Bio Instability Self-drilling Bone Tap, 2.4mm	C6177
Bio Instability Surgical Instrument Tray	C6178

All products may not be available in all markets.

LightWave®, Extended Length Suction Ablator

- » The LightWave® design incorporates a one-piece molded handle, which is plugged directly into the monopolar port of a standard electro-surgical generator
- » The LightWave Suction Ablator features hand controls, adjustable roller clamp suction control and a universal suction tubing adapter

Cat. No.

4.0mm dia. x 165mm length, 90° angle, suction..... EL-2000-S

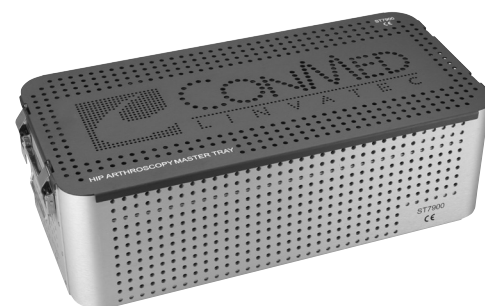

Hip Arthroscopy Sterilization Tray ST7900

Hip Preservation System Brochure CBR 8007

All products may not be available in all markets.

SMALL JOINT ARTHROSCOPY PRODUCTS

All products may not be available in all markets.

Standard Graspers

	Cat. No.
2mm dia., 65mm	
Straight.....	15.6001
2.75mm dia., 65mm	
Straight.....	17.6001
2mm dia., 90mm	
Straight.....	15.7001
2.75mm dia., 90mm	
Straight.....	17.7001

Mosquito Tip Graspers

2mm dia., 65mm	
Straight.....	15.6004
2.75mm dia., 65mm	
Straight.....	17.6004
2mm dia., 90mm	
Straight.....	15.7004
2.75mm dia., 90mm	
Straight.....	17.7004

45° Forceps

2mm dia., 65mm	
Blunt Tip, Right.....	35.60013
Blunt Tip, Left	35.60014
Scoop Tip, Right.....	35.60017
Scoop Tip, Left.....	35.60018
2.75mm dia., 65mm	
Blunt Tip, Right.....	32.60013
Blunt Tip, Left	32.60014
2mm dia., 90mm	
Blunt Tip, Right.....	35.70013
Blunt Tip, Left	35.70014
2.75mm dia., 90mm	
Blunt Tip, Right.....	32.70013
Blunt Tip, Left	32.70014

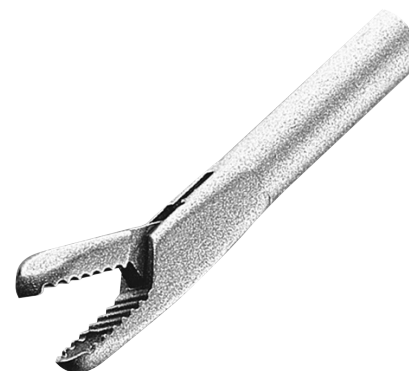

Standard Grasper

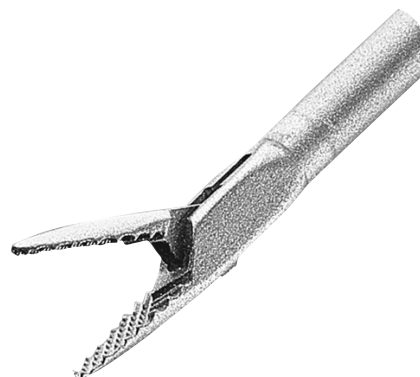

Mosquito Tip Grasper



45° Forceps

All products may not be available in all markets.

Small Joint Forceps and Graspers

Shutt® Line Of Manual Instruments



SST Blunt Tip Forceps



SST Scoop Tip Forceps

Shutt Square Trimmer (SST) Blunt Tip Forceps

	Cat. No.
2mm dia., 65mm	
Straight.....	5.6009
15° Down.....	5.60013
15° Up.....	5.60014
2.75mm dia., 65mm	
Straight.....	2.6009
15° Down.....	2.60013
2mm dia., 90mm	
Straight.....	5.7009
2.75mm dia., 90mm	
Straight.....	2.7009

SST Scoop Tip Forceps

2mm dia., 65mm	
Straight.....	5.6004
15° Down.....	5.60015
15° Up.....	5.60016
2.75mm dia., 65mm	
15° Down.....	2.60015
2mm dia., 90mm	
Straight.....	5.7004
15° Up.....	5.70016
2.75mm dia., 90mm	
Straight.....	2.7004
15° Down.....	2.70015

All products may not be available in all markets.

Suggested Instruments For Master Small Joint Set*

(Includes basic small joint set and the following additions)

	Cat. No.
2.75mm dia., 65mm	
SST Blunt Tip Forceps, 15° Down	2.60013
45° Forceps, Blunt Tip, Right.....	32.60013
45° Forceps, Blunt Tip, Left.....	32.60014
2.75mm dia., 90mm	
SST Scoop Tip Forceps, Straight.....	2.7004
45° Forceps, Blunt Tip, Right.....	32.70013
45° Forceps, Blunt Tip, Left.....	32.70014
2.4mm dia., 65mm	
Banana Blade Knife (4 per Box, Sterile)	9973
Retrograde Blade Knife (4 per Box, Sterile)	9974

Suggested Instruments For Basic Small Joint Set

2.75mm dia., 65mm	
Standard Grasper, Straight.....	17.6001
Mosquito Tip Grasper, Straight.....	17.6004
SST Blunt Tip Forceps, Straight	2.6009
SST Scoop Tip Forceps, 15° Down	2.60015
2.75mm dia., 90mm	
Standard Grasper, Straight.....	17.7001
Mosquito Tip Grasper, Straight.....	17.7004
SST Blunt Tip Forceps, Straight	2.7009
SST Scoop Tip Forceps, 15° Down	2.70015
65mm Instruments	
Probe, 70° tip	26.3003
Instrument Stabilizer Ball	326.000
Open Curette.....	22.6005
Dissector.....	22.6008
90mm Instruments	
Probe, 70° Tip	26.7003
Open Curette.....	22.7005
Dissector.....	22.7008

Small Joint Instrument Case

Similar to the larger instrument cases, the small joint case contains an instrument stand specifically designed for Shutt® small joint forceps. The stand can hold 10 ring-handled instruments. A storage tray with built-in silicone cushion is included.

Small Joint Instrument Case	
Dimensions: 9.25"w x 5.25"h x 9"d	9896



Small Joint Instrument Case

All products may not be available in all markets.

Small Joint Probes, Curettes and Dissectors

Shutt® Line Of Instruments

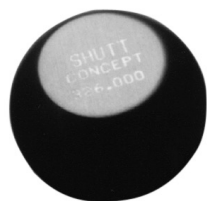

Instrument Stabilizer Ball



Small Joint Probe

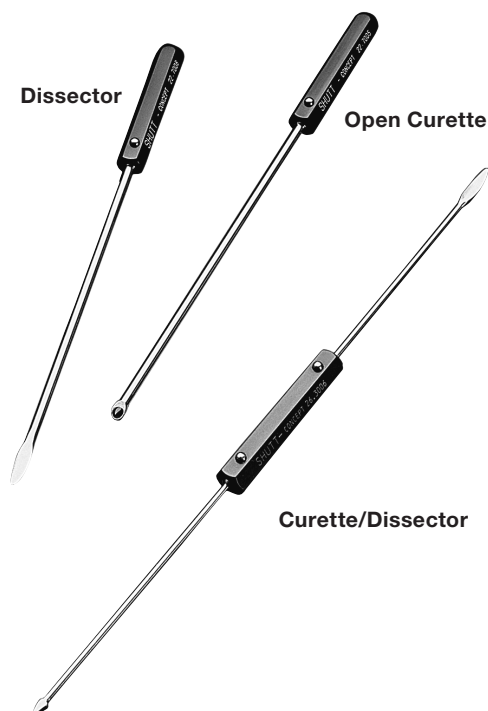

Dissector

Open Curette

Curette/Dissector

Small Joint Probe

- » Designed for 360° rotation in joint
- » Lightweight for fingertip control
- » Indexed handle for proper orientation
- » Angled tip for ease of insertion

Cat. No.

65mm Small Joint Probe, 70° Tip.....	26.3003
90mm Small Joint Probe, 70° Tip.....	26.7003
90mm Small Joint Probe, 30° Tip.....	26.7103
Instrument Stabilizer Ball	326.000

Small Joint Curette/Dissector

- » Uniquely designed for a wide range of applications
- » Atraumatic dissector tip useful to test ligament integrity and for lysis of adhesions
- » Angle-faced curette tip is tapered for ease of insertion and protection of articular surfaces
- » Handle indexed on each end for proper orientation with joint

2.75mm dia., 65mm

Curette/Dissector	26.3006
Open Curette.....	22.6005
Dissector.....	22.6008

2.75mm dia., 90mm

Open Curette.....	22.7005
Cupped Curette	26.7006
Dissector.....	22.7008

All products may not be available in all markets.

Small Joint Arthroscopy Knives

- » Hexagonal handle for positive grip and control
- » Three blade designs for proper tissue dissection:
 1. Versatile banana blade
 2. Retrograde blade for cutting loose tissue
 3. Smillie blade for cutting along edge of bony surfaces
- » Indexed for proper orientation
- » Packaged sterile, single-use, four per box
- » Small joint knives are available in a 65mm length

Cat. No.

Banana Blade.....	9973
Retrograde Blade.....	9974
Smillie Blade	9975

Banana Blade

Smillie
Blade

Retrograde
Blade

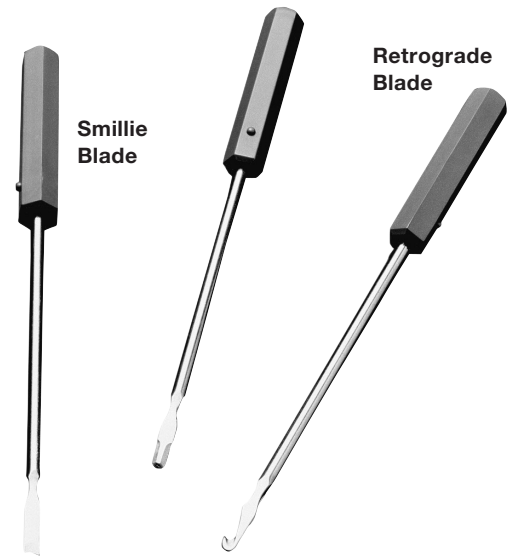

Small Joint Tubing And Cannula Set

Cannula and Tubing features:

- » Beveled atraumatic tip
- » Barbed design to prevent slippage
- » Syringe injection port
- » Inside diameter designed to maintain correct flow rate for clear field of vision and proper joint distension
- » Series of one-way valves to prevent backflow
- » Convenient hand pump to purge visual field
- » Polyvinyl chloride material, latex free
- » Packaged sterile, single-use, five per box

Set includes:

- » 2mm O.D. inflow cannula with matching needle
- » 60" inflow tubing with one-way valves
- » 3cc syringe
- » Landmark probe

Small Joint Tubing and Cannula Set	9350
--	------

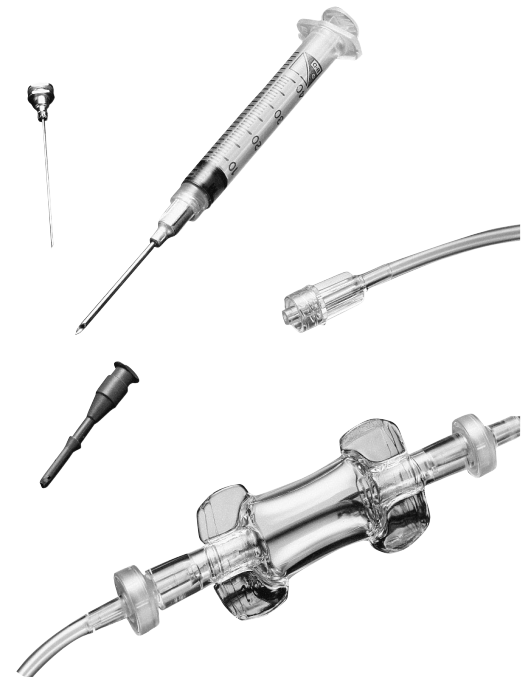

All products may not be available in all markets.



CTS Relief Kit®

- » Provides the surgeon with a set of simple to use, disposable instruments for endoscopic release of the transverse carpal ligament through a single portal
- » Endoscopic technique reduces post-operative pain and recovery time for the patient
- » Allows the surgeon to resect the ligament under direct visualization through a standard 4mm arthroscope
- » "D"-shaped, slotted cannula helps to shield adjacent neurovascular structures from potential damage
- » Pen-like knife handle improves the surgeon's tactile feel and control of the instrument while cutting

Cat. No.

CTS Relief Kit (4 Sterile Kits per Box)9971

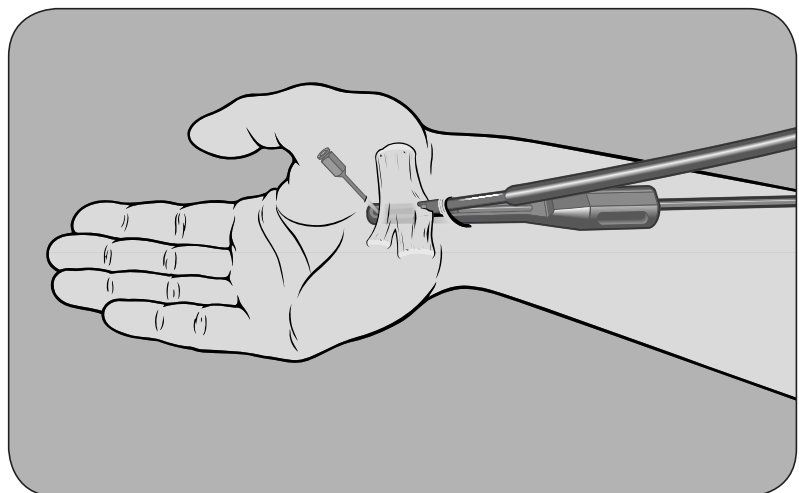

All products may not be available in all markets.

TractionTower® Extremity Traction Device

The TractionTower provides a complete, sterile method for securing and distracting the hand, wrist or forearm for arthroscopic procedures and fracture reductions. A tension scale ensures precise traction maintenance and monitoring. An adjustable ball joint enables wrist flexion and extension, as well as radial or ulnar deviation. Set-up configurations allow for both dorsal and volar approaches, and an x-ray cassette bracket makes it easy to obtain intraoperative x-rays. An autoclavable case is available for convenient storage and sterilization. The stand-alone design of the TractionTower allows stability without fixation to an operating table. Between cases, the system is easily disassembled for cleaning.

	Cat. No.
TractionTower	9905A
Includes the Following:	
Wrist Strap, 19" (Replacement)	9902
Forearm Strap, 20" (Replacement)	9907
Upper Arm Strap, 6', with foam (Replacement)†	9909

Optional Components:

TractionTower Sterilization Case	9912
TractionTower Cooling Bin	9904
DVD Technique Video	DVD0013

†Foam pad included with replacement.

Digit Trap®

Digit Trap provides an atraumatic method of securing a patient's fingers. A hook at the distal end of each Digit Trap allows usage either with or without the TractionTower. Digit Trap is packaged sterile, single-use.

Digit Trap (2 per Pkg., 10 Pkgs. per Box) Small.....	9906
Digit Trap (2 per Pkg., 10 Pkgs. per Box) Large	9903

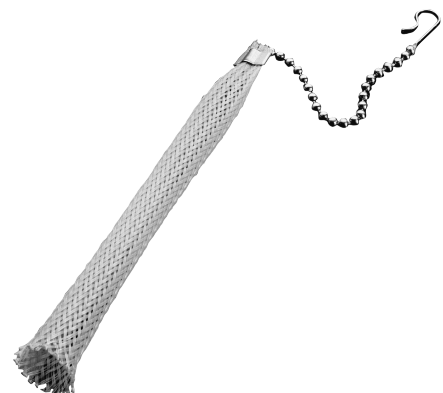

All products may not be available in all markets.



Mini Revo® Suture Anchor

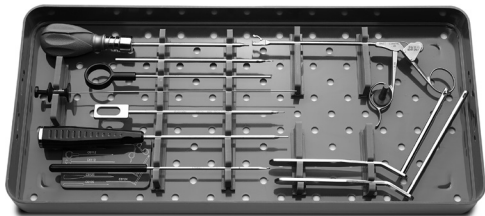

Mini Revo® Suture Anchor

- » 2.7mm wide threads provide superior bone purchase
- » Now with larger size eyelet for improved knot tying
- » Pre-loaded with 2, coated polyester suture
- » For use with the Mini Revo suture anchor system
- » Can be safely and completely retrieved from bone
- » Mini Revo can be introduced into the joint without a cannula

Cat. No.

Mini Revo Suture Anchor, 2.7mm O.D. (1.5mm I.D.) x 8.5mm (Pre-loaded W/2 Polyester Suture).....	C6109A
<small>Implants sold sterile.</small>	

Instruments

Mini Revo Driver	C6110A
Mini Revo Drill Guide	C6116
Revo/Mini Revo Suture Threader	C6113
Mini Revo Bone Punch, 1.5mm dia.....	C6114
Mini Revo Drill Bit, 1.5mm dia.....	C6115A
Mini Revo Remover Guide	C6124
Mini Revo Remover.....	C6125
Mini Revo Tap.....	C6128
Loop Handle Knot Pusher.....	C6112
Crochet Hook	C6105
Low Profile, Slotted Jaw, Suture Punch, 4mm Needle	18.1008
Low Profile, Slotted Jaw, Suture Punch, 7mm Needle	18.100124
Basic Instrument Tray with Lid	C6117

Accessories

Knot Pusher	8748
Teaser® Knot Tier.....	C8004
Micro Scissors, 2.75mm dia., Straight.....	2.10011
Suture Retrieval Forceps, 3.4mm dia.....	16.1018
Blitz® Suture Retriever, Straight (6 per Box Sterile)	C6111
Blitz Suture Retriever, 45° Left (6 per Box Sterile).....	C6211
Blitz Suture Retriever, 45° Right (6 per Box Sterile).....	C6311
Shuttle-Relay™ Suture Passer (10 per Box Sterile)	C6004
Liberator™ Knife	25.50014
Rasp Liberator	25.50016

The Revo suture anchor is titanium alloy per ASTM F-136. Packaged sterile, single-use. Warning: This device is not approved for screw attachment or fixation to the posterior elements (pedicles) of the cervical, thoracic or lumbar spine. The Blitz, Hawkeye, and Shuttle Relay are packaged sterile, single-use.

UltraFix® MicroMite® Small Joint Suture Anchor

Small Size, Rigid Fixation

The UltraFix MicroMite Suture Anchor System offers superior holding strength and small size in an easy-to-use system. With an optimal predeployed diameter of 1.5mm, the UltraFix MicroMite Anchor can be used ideally in the following indications:

- Wrist and hand
 - » Ulnar or lateral collateral ligament reconstruction
 - » Scapholunate ligament reconstruction
 - » PIP joint reconstructions

- Foot and Ankle
 - » Hallux valgus reconstructions
 - » Midfoot reconstruction

Inserter Facilitates Placement

The ergonomically designed UltraFix MicroMite Insertion Gun makes anchor placement quick and easy for any procedure. It allows one-handed insertion and hole marking. Your hand does not block the line of sight and no pushing is required. The UltraFix MicroMite Anchor is locked on the Insertion Gun until you release it — no “stay” suture is required. Proper placement and alignment can be checked before deployment. Tactile and audible feedback indicate when the anchor is locked in place.

	Cat. No.
1.5mm UltraFix MicroMite StitchPak® (Sterile Pre-loaded W/2-0 Suture & Needles), 1 ea.	10301
Drill Guide, 6pt	10298
Drill, 1.8mm	10297
Insertion Gun.....	10299
Instrument Tray	10300



UltraFix® MicroMite®



Drill Guide



Drill



Insertion Gun

All products may not be available in all markets.

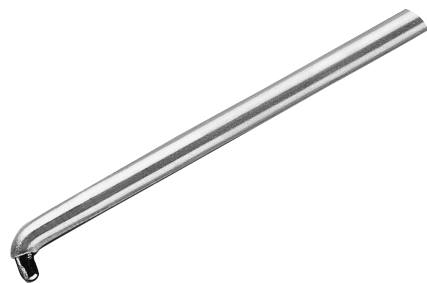

Small Joint Electrode, 90° Angled Design

Indicated for procedures of the TMJ, wrist and other small joints, the 90° angled tip is effective for the cutting and hemostasis of soft tissue encountered during surgery.

75mm (2.9")

Cat. No.

Basic Kit	8323BA
Mini-Kit.....	8322A

Basic Kits include an ESA electrode and handswitching pencil with safety holster.
Mini-Kits include an ESA electrode, handswitching pencil with safety holster, and dispersive patient pad.

For more information see Section: ESA Electrosurgical Arthroscopy Products.



UltrAblator®

UltrAblator®

Indicated for procedures of the wrist, ankle, elbow, and other small joints, the UltrAblator is effective for ablation of soft tissue and coagulation of bleeders encountered during surgery.

60mm length x 2.5mm dia.

30° Angle	ESA-5234
90° Angle	ESA-5294



Heatwave®

Heatwave®

Indicated for procedures of the wrist, ankle, elbow, and other small joints, the Heatwave is effective in modification of soft tissue and ligaments.

60mm length x 2.3mm dia.

Flex-Tip (Bendable Tip Design)	CS-024
--------------------------------------	--------

All products may not be available in all markets.

FRACTURE FIXATION PRODUCTS

All products may not be available in all markets.

1.5mm Bone Fixation Kit

Self-Reinforced 96L/4D PLA Implant

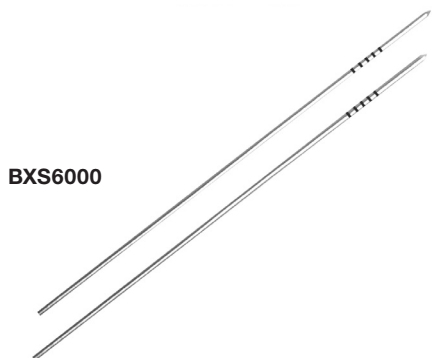
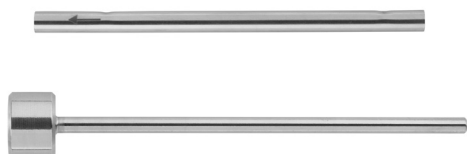

BXS6000

The 1.5mm Bone Fixation Kit provides surgeons with a simple, safe and resorbable solution for bone fixation, delivering maximum patient comfort and optimizing outcomes.

- » Instruments and implants in one package, Requires no separate instrument tray
- » Packaged as single or double, One or two points of fixation
- » Sterile packed, Disposable
- » Calibrated K-Wires, Easy to measure

Cat. No.

1.5mm Bone Fixation Kit, 14mm, 1.5mm Outer Diameter (O.D.) x 16mm Length (L)	BXS6114
1.5mm Bone Fixation Kit, 16mm, 1.5mm O.D. x 16mm L.....	BXS6116
1.5mm Bone Fixation Kit, 18mm, 1.5mm O.D. x 18mm L.....	BXS6118
1.5mm Bone Fixation Kit, 20mm, 1.5mm O.D. x 20mm L.....	BXS6120
1.5mm Bone Fixation Kit, 25mm, 1.5mm O.D. x 25mm L.....	BXS6125
1.5mm Bone Fixation Kit, 16mm (2), 1.5mm O.D. x 16mm L.....	BXS6216
1.5mm Bone Fixation Kit, 18mm (2), 1.5mm O.D. x 18mm L.....	BXS6218
1.5mm Bone Fixation Kit, 20mm (2), 1.5mm O.D. x 20mm L.....	BXS6220
1.5mm Bone Fixation Kit, 25mm (2), 1.5mm O.D. x 25mm L.....	BXS6225
1.5mm Bone Fixation Kit, K-Wires (2), 1.5mm O.D. x 114mm L.....	BXS6000

All products may not be available in all markets.

- » Provides excellent non-load bearing immobilization of cancellous bone fragments
- » Eliminates the need for implant removal
- » No stress shielding
- » Self-Reinforced technology allows CONMED to manufacture a strong absorbable pin

SmartPin Implants, made of PLLA, are available individually packed and sterile in a wide range of sizes and lengths.

Cat. No.

SmartPin Implants (PLLA)

SmartPin 1.1mm, 10, 20, 30, 40mm.....	121110 – 121140
SmartPin 1.5mm, 10, 20, 30, 40, 50, 60, 70mm.....	121510 – 121570
SmartPin 2.0mm, 20, 25, 30, 35, 40, 50, 60, 70mm.....	122020 – 122070
SmartPin 3.2mm, 30, 40, 50, 60, 70mm.....	123230 – 123270
SmartPin 4.5mm, 40, 50, 60, 70mm.....	124540 – 124570

Instrument Set

Instrument Tray	AC0001
Handle	AA1520-01
Housing (for Percutaneous Use)	AA1520-04
Wrench	AA1520-05

SmartPin Instruments

Arthroscopic:

Arthroscopic Tip, 1.5mm x 70mm*.....	AA1520-021
Arthroscopic Tip, 2.0mm x 70mm*	AA1520-022
Arthroscopic Piston, 1.5mm x 94.5mm	AA1520-031
Arthroscopic Piston, 2.0mm x 94.5mm	AA1520-032
Arthroscopic Drill Bit, 1.5mm x 210mm.....	AA1520-061
Arthroscopic Drill Bit, 2.0mm x 210mm.....	AA1520-062
K Wire 2 per Box, 1.5mm x 170mm	AA1520-07

Percutaneous:

Percutaneous Tip, 1.5mm x 30mm*	AP1520-021
Percutaneous Tip, 2.0mm x 30mm*	AP1520-022
Percutaneous Piston, 1.5mm x 60mm.....	AP1520-031
Percutaneous Piston, 2.0mm x 60mm	AP1520-032
Percutaneous Drill Bit, 1.5mm x 170mm	AP1520-061
Percutaneous Drill Bit, 2.0mm x 170mm	AP1520-062

Reusable Applicators:

Reusable Applicator, 1.1mm	AA1100
Reusable Applicator, 1.5mm	AA1500
Reusable Applicator, 2.0mm	AA2000
Reusable Applicator, 3.2mm	AA3200
Reusable Applicator, 4.5mm	AA4500

Accessories

Obturator, 3.2mm.....	AA1520-08
Arthroscopic Tip, 3.2mm x 70mm.....	AA1520-023
Arthroscopic Piston, 3.2mm x 95mm	AA1520-033

* Working length when tip is connected to handle.
Specifications subject to change without notice.



All products may not be available in all markets.

ARTHROSCOPY MANUAL INSTRUMENTS

Shutt® Manual Instruments keep getting better. Shutt has come a long way in setting the standards for arthroscopic instrumentation. As a result of Shutt being an early pioneer in the field, the first arthroscopic hook punch forceps was produced in 1980.

Shutt has earned a reputation for precise, dependable instruments. With an unsurpassed commitment to service, Shutt has met your needs time and time again. Our instruments feature a barber-tang handle for a sensitive touch and a large thumb ring for long-term comfort. A special coating on the actuator guarantees a smooth cutting action. Precision-matched, diamond-honed tips assure a clean, close cut.

Today and into the future, our engineers strive for improvements. The latest Shutt forceps and graspers feature a stronger tube and are laser welded at the shaft tip and base. A heavy duty shear pin stands up to the toughest tissue. A glass bead finish is easy to clean and gives each instrument a highly-professional look and feel.

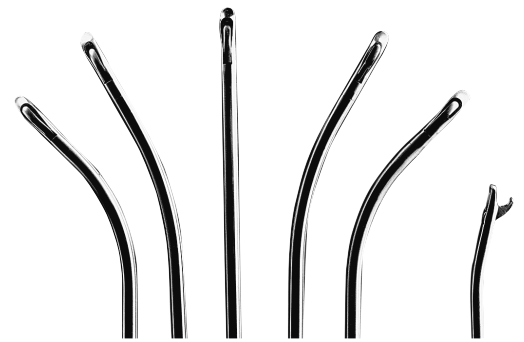

Shutt forceps are available in a wide range of shaft configurations including straight, 15°, 30° and 45° right and left curves, as well as a 15° up curve.



Shutt® Forceps



Shutt Small Joint Forceps

All products may not be available in all markets.



Shutt® Blunt Tip Forceps



Shutt B-Scoop Forceps



Shutt Mini-Tip Forceps



Shutt Shovel Nose Forceps

Blunt Tip Forceps
3.4mm dia., 130mm

	Cat. No.
Straight.....	1.1001
30° Left.....	1.1211
30° Right.....	1.1221
15° Up.....	1.1631

B-Scoop Forceps
3.4mm dia., 130mm

Straight.....	1.1002
30° Left.....	1.1212
30° Right.....	1.1222
45° Left.....	1.1412
45° Right.....	1.1422
15° Up.....	1.1632

Mini-Tip Forceps
2.75mm dia., 130mm

Straight.....	2.1003
30° Left.....	2.1113
30° Right.....	2.1123
15° Up.....	2.1633

3.4mm dia., 130mm

Straight.....	1.1003
30° Left.....	1.1213
30° Right.....	1.1223
15° Up.....	1.1633

Custom Mini-Tip Forceps
2.75mm dia., 130mm

45° Left.....	2.1413
45° Right.....	2.1423

Shovel Nose Forceps
3.4mm dia., 130mm

Standard, Straight.....	4.1002
Mini, Straight.....	4.1003
Standard, 15° Up.....	4.1632
Mini, 15° Up.....	4.1633

All products may not be available in all markets.

90° Rotary Forceps
3.4mm dia., 130mm

	Cat. No.
Blunt Tip, Blunt, Right.....	41.10021
Blunt Tip, Blunt, Left.....	41.10022
Square Tip, Scoop, Right.....	41.10025
Square Tip, Scoop, Left.....	41.10026

3.4mm dia, 130mm Square

Blunt Tip, Blunt, Right.....	41.1001
Blunt Tip, Blunt, Left.....	41.1002
Square Tip, Scoop, Right.....	41.1005
Square Tip, Scoop, Left.....	41.1006

90° Forceps
3.4mm dia., 130mm

Blunt Tip, Right.....	31.1001
Blunt Tip, Left.....	31.1002
Scoop Tip, Right.....	31.1005
Scoop Tip, Left.....	31.1006

Series 210°

Blunt Tip, Left.....	S210RFL
Blunt Tip, Right.....	S210RFR

Low-Profile Forceps
2.75mm dia., 130mm

Straight.....	32.10019
15° Up.....	32.16319

3.4mm dia., 130mm

Straight.....	31.10019
15° Up.....	31.16319

Aggressor® Forceps
3.4mm dia., 130mm

Straight.....	31.10034
15° Up.....	31.16334
15° Left.....	31.16136
15° Right.....	31.16235

Series 210

15° Up.....	S210AFU
Left.....	S210AFL
Right.....	S210AFR



Shutt® 90° Rotary Forceps



Shutt 90° Forceps



Shutt Low-Profile Forceps



Shutt Aggressor® Forceps

All products may not be available in all markets.



Shutt® Mini-Aggressor® Forceps



Shutt 45° Forceps



Shutt Retrograde Forceps

Mini-Aggressor® Forceps
2.75mm dia., 130mm

	Cat. No.
Straight.....	32.10034
15° Up.....	32.16334

3.4mm dia., 130mm

Straight.....	31.10033
15° Up.....	31.16333
30° Left.....	31.12133
30° Right.....	31.12233

Custom Mini-Aggressor Forceps
2.75mm dia., 130mm

30° Left.....	32.11134
30° Right.....	32.11234

45° Forceps
2.75mm dia., 130mm

Blunt Tip, Right.....	32.10013
Blunt Tip, Left.....	32.10014
Blunt Tip, Right, 15° Up.....	32.16313
Blunt Tip, Left, 15° Up.....	32.16314
Scoop Tip, Right.....	32.10017
Scoop Tip, Left.....	32.10018

3.4mm dia., 130mm

Blunt Tip, Right.....	31.10013
Blunt Tip, Left.....	31.10014
Scoop Tip, Right.....	31.10017
Scoop Tip, Left.....	31.10018

Retrograde Forceps

Straight, Left Bite.....	C3007.0
Straight, Right Bite.....	C3007.1
15° Up, Right Bite.....	C3007.2
15° Up, Left Bite.....	C3007.3
Series 210°.....	S210RGF

All products may not be available in all markets.

Shutt® Square Trimmer (SST) Forceps
2.75mm dia., 130mm

	Cat. No.
Blunt Tip, Straight.....	2.1039
Blunt Tip, 15° Up.....	2.1639
Scoop Tip, Straight.....	2.1004
Scoop Tip, 15° Up.....	2.1634

3.4mm dia., 130mm

Blunt Tip, Straight.....	1.1039
Blunt Tip, 30° Left.....	1.1219
Blunt Tip, 30° Right.....	1.1229
Blunt Tip, 15° Up.....	1.1639
Scoop Tip, Straight.....	1.1004

Custom SST Forceps
2.75mm dia., 130mm

Blunt Tip, 30° Left.....	2.1119
Blunt Tip, 30° Right.....	2.1129

Suture Retrieval Forceps
3.4mm dia., 130mm

Straight.....	16.1018
Series 210°.....	S210SRF

Standard Scissors
2.75mm dia., 130mm

Straight.....	2.10012
---------------	---------

3.4mm dia., 130mm

Straight.....	1.10012
---------------	---------



Shutt® Square Trimmer (SST)
Blunt Tip, Straight Forceps



Shutt Straight Suture Retrieval Forceps



Shutt Standard Scissors

All products may not be available in all markets.



Shutt® Micro-Scissors



Shutt Alligator Grasper



Shutt Grasping Forceps

Micro-Scissors
2.75mm dia., 130mm

	Cat. No.
Straight.....	2.10011
30° Left.....	2.11111
30° Right.....	2.11211
15° Up.....	2.16311

3.4mm dia., 130mm

Straight.....	1.10011
30° Left.....	1.12111
30° Right.....	1.12211
45° Right.....	31.10011
45° Left.....	31.10012
Series 210®.....	S210MSC

Alligator Grasper
2.75mm dia., 130mm

Straight, w/Ratchet.....	12.1002
15° Up, w/Ratchet.....	12.1632

3.4mm dia., 130mm

Straight, w/Ratchet.....	11.1002
15° Up, w/Ratchet.....	11.1632

4.5mm dia., 130mm

Straight, w/Ratchet.....	18.1002
--------------------------	---------

Grasping Forceps
2.75mm dia., 130mm

Straight, w/Ratchet.....	12.1001
--------------------------	---------

3.4mm dia., 130mm

Straight, w/Ratchet.....	11.1001
Straight, w/o Ratchet.....	16.1001

4.5mm dia., 130mm

Straight, w/Ratchet.....	18.1001
Series 210.....	S210GSP

Custom Grasping Forceps
2.75mm dia., 130mm

Straight, w/o Ratchet.....	17.1001
----------------------------	---------

4.5mm dia., 130mm

Straight, w/o Ratchet.....	19.1001
----------------------------	---------

All products may not be available in all markets.

Shutt® Suction Punch Forceps/Suction Graspers

Shutt Suction Punch Forceps provide superior tissue excision with precision-matched, diamond-honed tips. Shutt Suction Graspers offer an aggressive tooth pattern to capture loose bodies drawn into the jaws. Both feature a unique stress pin buffering system to minimize tip breakage within a joint. In use, the stress pin buffering system applies increasing tension to the instrument handle, indicating that pressure is being directed towards the stress pin. The stress pin buffering system is incorporated in a three-stage actuating mechanism: Stage One, aspiration control; Stage Two, tissue cutting; Stage Three, stress pin buffering.

Cat. No.

3.4mm dia. Suction Punch Forceps, Blunt.....	51.1001
4.5mm dia. Suction Punch Forceps, Blunt.....	58.1001
4.5mm dia. Suction Grasper	58.1003



Shutt® Blunt Suction Punch Forceps

All products may not be available in all markets.



Shutt® Master Instrument Tray

Suggested Instruments For Master Set 2.75mm dia., 130mm

	Cat. No.
SST Forceps, Blunt Tip, Straight	2.1039
Micro-Scissors, Straight	2.10011
Mini-Tip Forceps, Straight.....	2.1003
Mini-Tip Forceps, 15° Up.....	2.1633
45° Forceps, Blunt Tip, Left, 15° Up.....	32.16314
Mini-Aggressor® Forceps, 15° Up.....	32.16334

3.4mm dia., 130mm

B-Scoop Forceps, Straight.....	1.1002
SST Forceps, Blunt Tip, Straight	1.1039
45° Forceps, Blunt Tip, Right.....	31.10013
Mini-Aggressor Forceps, Straight.....	31.10033
Aggressor Forceps, Straight.....	31.10034
Aggressor Forceps, 15° Up.....	31.16334
Aggressor Forceps, 15° Right	31.16235
Aggressor Forceps, 15° Left.....	31.16136
90° Rotary Forceps, Square Tip, Blunt, Right	41.1001
90° Rotary Forceps, Square Tip, Blunt, Left	41.1002
Alligator Grasper, Straight	11.1002
Retrograde Forceps, Straight, Left Bite.....	C3007.0
Retrograde Forceps, 15° Up, Right Bite.....	C3007.2

4.5mm dia., 130mm

Alligator Grasper, Straight	18.1002
Master Instrument Tray 16"w x 10"l x 5"h (Accommodates Up To Twenty Shutt® Instruments).....	9879

Suggested Instruments For Basic Set 2.75mm dia., 130mm

Mini-Tip Forceps, Straight.....	2.1003
Mini-Tip Forceps, 15° Up.....	2.1633
45° Forceps, Blunt Tip, Left, 15° Up.....	32.16314
Mini-Aggressor Forceps, 15° Up.....	32.16334

3.4mm dia., 130mm

45° Forceps, Blunt Tip, Right.....	31.10013
Aggressor Forceps, Straight.....	31.10034
90° Rotary Forceps, Square Tip, Blunt, Right	41.1001
90° Rotary Forceps, Square Tip, Blunt, Left	41.1002
Alligator Grasper, Straight	11.1002
Retrograde Forceps, Straight, Right Bite.....	C3007.1
Instrument Tray 9"w x 10"l x 5.2"h (Accommodates Up To Ten Concept Instruments).....	9899A

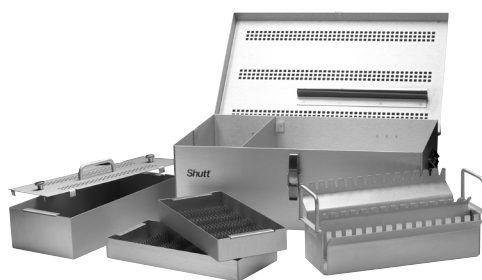

All products may not be available in all markets.

Rotary Punch
3.3mm dia., 130mm

	Cat. No.
90° Left	C6850
90° Right	C6851

Linear Wide Bite Punch
3.3mm dia., 130mm

Straight	C6855
----------------	-------

Linear Wide Bite Punch
3.3mm dia., 130mm

15° Up	C6856
--------------	-------

Linear Wide Bite Punch
3.3mm dia., 130mm

15° Upswept	C6857
-------------------	-------



90° Left Rotary Punch



Straight Linear Wide Bite Punch



15° Up Linear Wide Bite Punch



C6857 15° Upswept Linear Wide Bite Punch

All products may not be available in all markets.



1.3mm Tip, Straight Linear Punch

Linear Punch
3.3mm dia., 130mm

Cat. No.

1.3mm Tip, Straight.....C6858



Narrow, Straight Linear Punch

Linear Punch
3.3mm dia., 130mm

Narrow, Straight.....C6806



15° Up Linear Punch

Linear Punch
3.3mm dia., 130mm

15° Up.....C6859



15° Up Linear Punch, Scissor

Linear Punch, Scissor
3.3mm dia., 130mm

15° Up.....C6860

All products may not be available in all markets.

Linear Alligator Grasper
3.3mm dia., 130mm

2.7mm Tip Cat. No. C6861

Rotary Scissors
3.3mm dia., 130mm

60° Right C6862

60° Left C6863

Linear Wide Bite Punch
3.3mm dia., 130mm

15° Blunt Nose C6866

Linear Punch Scissor
3.3mm dia., 130mm

Straight C6809



Linear Alligator Grasper



60° Right Rotary Scissors



Linear Wide Bite Punch



Straight Linear Punch Scissor

All products may not be available in all markets.



20° Left Rotary Scissors

Rotary Scissors
3.3mm dia., 130mm

	Cat. No.
20° Left.....	C6810
20° Right.....	C6811



Linear Grasper

Linear Grasper
3.3mm dia., 130mm

Large Body.....	C6812
-----------------	-------



Linear Wide Bite Punch

Linear Wide Bite Punch
3.3mm dia., 130mm

15° Up, left.....	C6804
15° Up, right.....	C6805



Linear Wide Bite Oblique Punch

Linear Wide Bite Oblique Punch
3.3mm dia., 130mm

25° Left.....	C6868
25° Right.....	C6869

All products may not be available in all markets.

Meniscal Lift Punch
1.7mm x 130mm

Straight..... Cat. No. C6700

Retro Punch
2.4mm x 130mm

Left..... C6701
Right..... C6702

Grasper, Cupped
3.4mm x 130mm

Straight..... C6703



Meniscal Lift Punch



Left Retro Punch



Right Retro Punch



Grasper, Cupped

All products may not be available in all markets.



Suture Tram® Retriever, Straight



Softjaw® Forked Tissue Grasper

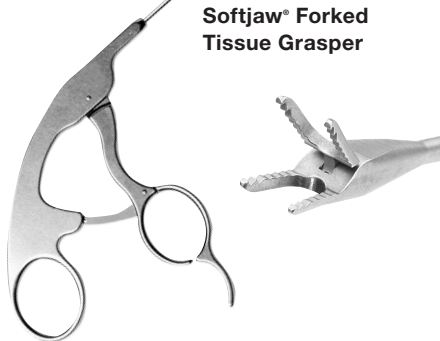

Concept® Instrument Tray

Suture Tram®
3.3mm dia., 130mm

Cat. No.

Retriever, Straight.....	C6800
Retriever, 15° Upswept.....	C6801

Softjaw® Grasper

Use for soft tissue graft manipulation or soft tissue approximation. The Softjaw Grasper was designed to grasp the tissue without tearing or cutting tissue fibers.

Softjaw Grasper.....	C8130
----------------------	-------

Forked Tissue Grasper.....	GU1000
----------------------------	--------

Concept® Instruments Basic Kit:
(all instruments are sold separately)

Linear Wide Bite Up 15° Curved Left Punch	C6804
Linear Wide Bite Up 15° Curved Right Punch	C6805
Linear Scissor Straight Punch	C6809
Linear Large Body Grasper	C6812
Rotary 90° Left Punch.....	C6850
Rotary 90° Right Punch.....	C6851
Linear Wide Bite Up 15° Punch.....	C6856
Linear Wide Bite Up 15° Upswept Punch	C6857
Linear 1.3mm Straight Punch.....	C6858
Linear 1.3mm 15° Punch.....	C6859
Linear Wide Bite Oblique 25° Left Punch.....	C6868
Linear Wide Bite Oblique 25° Right Punch.....	C6869
Instrument Tray 9"w x 10"l x 5.2"h (Accommodates Up to Ten Concept Instruments)	9899A

All products may not be available in all markets.

The MASTER Arthroscopy Shoulder Instrument Set is a comprehensive set of manual instruments that can be used for arthroscopic or mini-open shoulder repairs. The set has been designed to allow flexibility in suture passing and suture retrieving methods that are critical to success in these procedures.

Raven™ Suture Retriever

	Cat. No.
Straight, 3.5mm dia., 138mm	GU1004
35° Up, 3.5mm dia., 138mm	GU1008

Suture Snare™

Straight, 3.5mm dia., 138mm	GU1003
-----------------------------------	--------

Guillotine® Suture Cutter

Straight, 3.5mm dia., 139mm	GU1007
-----------------------------------	--------

Suture Scissor

Straight, 3.4mm dia., 136mm	GU1005
-----------------------------------	--------

Tissue Grasper

Straight, 3.5mm dia., 142mm	GU1002
-----------------------------------	--------

Accessories

Arthroscopic Probe	PR1001
Crochet Hook.....	PR1002
Ring Handled Knot Pusher.....	C6112
Switching Stick.....	2220
Instrument Tray.....	MT1006

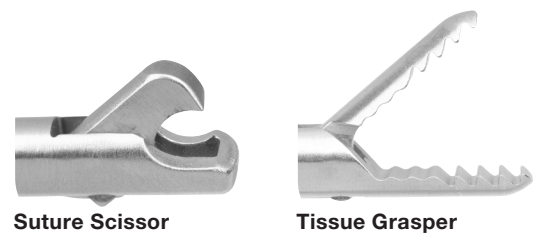
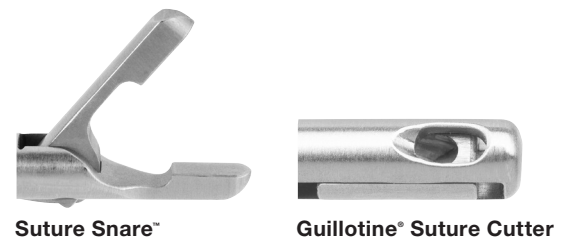
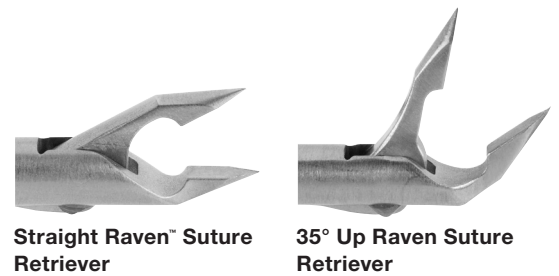

All products may not be available in all markets.

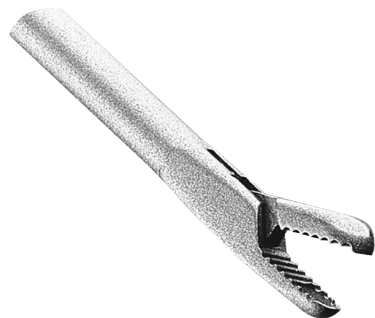

Standard Graspers Straight

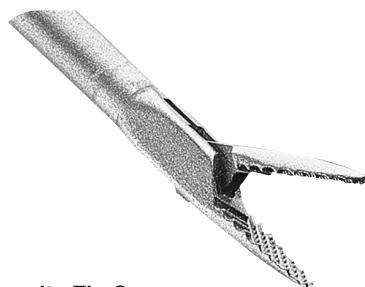

Mosquito Tip Graspers

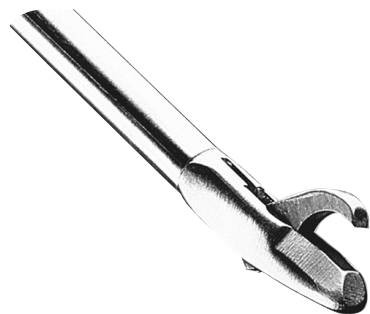

SST Blunt Tip Forceps

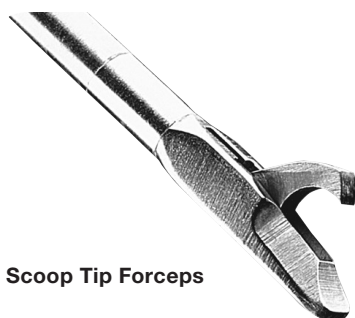

SST Scoop Tip Forceps

Standard Graspers

2mm dia., 65mm

Straight..... Cat. No. 15.6001

2.75mm dia., 65mm

Straight..... 17.6001

2mm dia., 90mm

Straight..... 15.7001

2.75mm dia., 90mm

Straight..... 17.7001

Mosquito Tip Graspers

2mm dia., 65mm

Straight..... 15.6004

2.75mm dia., 65mm

Straight..... 17.6004

2mm dia., 90mm

Straight..... 15.7004

2.75mm dia., 90mm

Straight..... 17.7004

SST Blunt Tip Forceps

2mm dia., 65mm

Straight..... 5.6009

15° Down..... 5.60013

15° Up..... 5.60014

2.75mm dia., 65mm

Straight..... 2.6009

15° Down..... 2.60013

2mm dia., 90mm

Straight..... 5.7009

2.75mm dia., 90mm

Straight..... 2.7009

SST Scoop Tip Forceps

2mm dia., 65mm

Straight..... 5.6004

15° Down..... 5.60015

15° Up..... 5.60016

2.75mm dia., 65mm

15° Down..... 2.60015

2mm dia., 90mm

Straight..... 5.7004

15° Up..... 5.70016

2.75mm dia., 90mm

Straight..... 2.7004

15° Down..... 2.70015

All products may not be available in all markets.

45° Forceps

	Cat. No.
2mm dia., 65mm	
Blunt Tip, Right.....	35.60013
Blunt Tip, Left.....	35.60014
Scoop Tip, Right.....	35.60017
Scoop Tip, Left.....	35.60018

2.75mm dia., 65mm	
Blunt Tip, Right.....	32.60013
Blunt Tip, Left.....	32.60014

2mm dia., 90mm	
Blunt Tip, Right.....	35.70013
Blunt Tip, Left.....	35.70014

2.75mm dia., 90mm	
Blunt Tip, Right.....	32.70013
Blunt Tip, Left.....	32.70014

**Suggested Instruments For Master Small Joint Set*
(Includes Basic Small Joint Set and the following additions)**

2.75mm dia., 65mm	
SST Blunt Tip Forceps, 15° Down.....	2.60013
45° Forceps, Blunt Tip, Right.....	32.60013
45° Forceps, Blunt Tip, Left.....	32.60014

2.75mm dia., 90mm	
SST Scoop Tip Forceps, Straight.....	2.7004
45° Forceps, Blunt Tip, Right.....	32.70013
45° Forceps, Blunt Tip, Left.....	32.70014

2.4mm dia., 65mm	
Banana Blade Knife (4 per Box, Sterile).....	9973
Retrograde Blade Knife (4 per Box, Sterile).....	9974

**Suggested Instruments For Basic Small Joint Set
2.75mm dia., 65mm**

Standard Grasper, Straight.....	17.6001
Mosquito Tip Grasper, Straight.....	17.6004
SST Blunt Tip Forceps, Straight.....	2.6009
SST Scoop Tip Forceps, 15° Down.....	2.60015

2.75mm dia., 90mm	
Standard Grasper, Straight.....	17.7001
Mosquito Tip Grasper, Straight.....	17.7004
SST Blunt Tip Forceps, Straight.....	2.7009
SST Scoop Tip Forceps, 15° Down.....	2.70015

65mm Instruments	
Probe, 70° Tip.....	26.3003
Instrument Stabilizer Ball.....	326.000
Open Curette.....	22.6005
Dissector.....	22.6008

90mm Instruments	
Probe, 70° Tip.....	26.7003
Open Curette.....	22.7005
Dissector.....	22.7008

Instrument Case 9.25"W x 5.25"H x 9"D (Accommodates Up to Ten Shutt Small Joint Instruments) Includes Accessory Tray.....	9896
--	------



45° Forceps Blunt Tip,

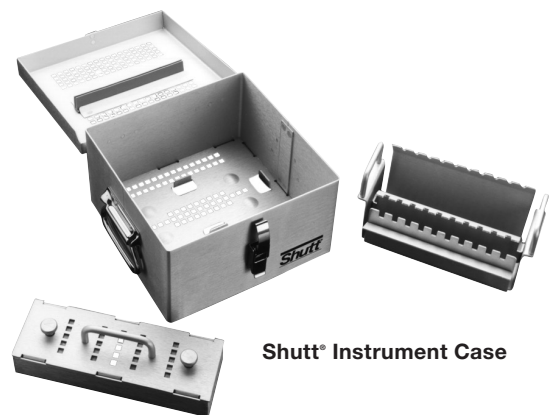

Shutt® Instrument Case

All products may not be available in all markets.

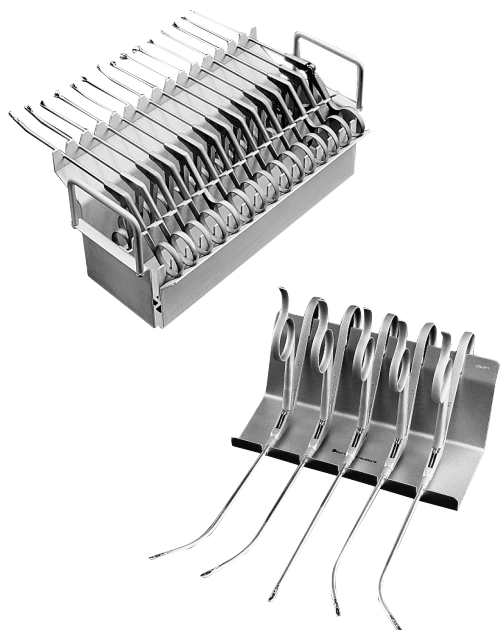

Deluxe Forceps Stand

Cat. No.

Deluxe Forceps Stand (Accommodates 15 ring-handled Shutt® and Concept®
Instruments) Dimensions: 11.75"w x 5"h x 5.25"d9898

Precision Probes

Shutt® probes are designed specifically for arthroscopic surgery. Unique handles give a firm grip and aid in instrument control. Shafts are hardened to resist breakage and tapered for better visualization. All straight probes have etched graduations in 5mm increments. All probes are limited-reuse and may be disinfected, steam autoclaved or ethylene oxide sterilized.

Probes available separately

	Cat. No.
4.0mm dia. Tip, Maxi-Probe, Straight, Green Handle.....	21.1002
3.5mm dia. Tip, Mini-Probe, Straight, Blue Handle.....	21.1001

Small Joint Probe

- » Designed for 360° rotation in joint.
- » Lightweight for fingertip control.
- » Indexed handle for proper orientation.
- » Angled tip for ease of insertion.

65mm Small Joint Probe, 70° Tip.....	26.3003
90mm Small Joint Probe, 70° Tip.....	26.7003
90mm Small Joint Probe, 30° Tip.....	26.7103
Instrument Stabilizer Ball.....	326.000

Small Joint Curette/Dissector

- » Uniquely designed for a wide range of applications.
- » Atraumatic dissector tip useful to test ligament integrity and for lysis of adhesions.
- » Angle-faced curette tip is tapered for ease of insertion and protection of articular surfaces.
- » Handle indexed on each end for proper orientation with joint.

2.75mm dia., 65mm

Curette/Dissector.....	26.3006
Open Curette.....	22.6005
Dissector.....	22.6008

2.75mm dia., 90mm

Open Curette.....	22.7005
Cupped Curette.....	26.7006
Dissector.....	22.7008



All products may not be available in all markets.

RESECTION PRODUCTS

	Cat. No.
D4000 Console.....	D4000
Height: 5.6" (14.2cm), Width: 14" (35.6cm), Depth: 16.5" (41.9cm), Weight: 14.5lbs (6.35kg)	
D4000A Console with Irrigation Pump.....	D4000A
Height: 5.6" (14.2cm), Width: 14" (35.6cm), Depth: 16.5" (41.9cm), Weight: 14.5lbs (6.35kg)	
Advantage® Console with Cord 115 Volt.....	D3000
Height: 5.125" (13cm), Width: 17" (43.2cm), Depth: 13" (35cm), Weight: 19.5lbs (8.86kg)	
Advantage Console with Cord 230 Volt.....	D3000I
Height: 5.125" (13cm), Width: 17" (43.2cm), Depth: 13" (35cm), Weight: 19.5lbs (8.86kg)	
Advantage Console with Cord 100 Volt.....	D3000J
Height: 5.125" (13cm), Width: 17" (43.2cm), Depth: 13" (35cm), Weight: 19.5lbs (8.86kg)	
Operates: Advantage Shavers, Apex® Shavers, PowerPro® Electric Handpieces, MicroChoice® Handpieces, Mini-Driver™ Handpiece and E9000® Handpieces	
E9000® Console with Cord 115 Volt.....	E9000
Height: 4.63" (29.25cm), Width: 11.75" (11.76cm), Depth: 12.25" (31.11cm), Weight: 15.4lbs (7.0kg)	
E9000 Console with Cord 230 Volt.....	E9000G
Height: 4.63" (29.25cm), Width: 11.75" (11.76cm), Depth: 12.25" (31.11cm), Weight: 15.4lbs (7.0kg)	
E9000 Console with Cord 100 Volt.....	E9000J
Height: 4.63" (29.25cm), Width: 11.75" (11.76cm), Depth: 12.25" (31.11cm), Weight: 15.4lbs (7.0kg)	
Operates: Advantage Shavers, Apex Shavers, MicroChoice Handpieces, Mini-Driver Handpiece and E9000 Handpieces	
ZEN® Wireless 3-Pedal Footswitch.....	W1000
(For use with Advantage, E9000, and PowerPro Consoles)	
Wireless Adapter for ZEN.....	W1100
(For use with Zen Wireless Footswitch)	
3-Pedal Footswitch.....	C9863
For use with Advantage, E9000 and PowerPro Consoles	
2-Pedal Footswitch.....	5020-053
For use with Advantage, E9000 and PowerPro Consoles	



D4000 Console



D4000A Console with Irrigation Pump



Advantage® Console



E9000® Console



**ZEN® Wireless
3-Pedal Footswitch**



**Wireless Adapter
for ZEN**



3-Pedal Footswitch



2-Pedal Footswitch

All products may not be available in all markets.



Cat. No.

Universal Handpiece Cord MC5057
 For use with Advantage®, E9000® and PowerPro® Consoles
 12' (3.6m)
 Operates: MicroChoice®, PowerPro, E9000 and MC Shaver Handpieces

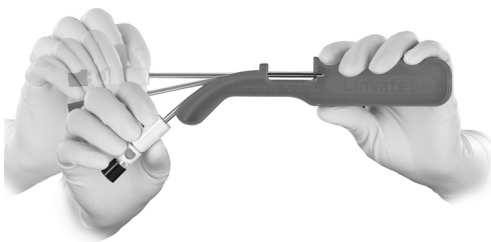

Merlin® Blade Bender P9305
 For use with all Merlin Bendable Shaver Blades



Shaver Blade and Bur De-Clogger E9315

All products may not be available in all markets.

	Cat. No.
Two-Button Ergo™ Shaver	D4240
Forward Speed 500-12,000rpm	
Oscillate Speed 500-2,500cpm, Single- and multi-turn oscillate	
For use with Large Hub Shaver Blades and Burs	
For use with Advantage, E9000®	
Weight: 17.8 oz. (505g)	
No-Button Ergo Shaver	D4200
Forward Speed 500-12,000rpm	
Oscillate Speed 500-2,500cpm, Single- and multi-turn oscillate	
For use with Large Hub Shaver Blades and Burs	
For use with Advantage, E9000®	
Weight: 17.8 oz. (505g)	
Two-Button Advantage® Turbo Shaver	D9924
Forward Speed 500-12,000rpm	
Oscillate Speed 500-2,500cpm, Single- and multi-turn oscillate	
For use with Large Hub Shaver Blades and Burs	
For use with Advantage, E9000®	
Weight: 17.8 oz. (505g)	
No-Button Advantage Turbo Shaver (Footswitch Only).....	D9920
Forward Speed 500-12,000rpm	
Oscillate Speed 500-2,500cpm, Single- and Multi-turn Oscillate	
For use with Large Hub Shaver Blades and Burs	
For use with Advantage, E9000	
Weight: 17.8 oz. (505g)	
Thorne ½" Chuck.....	D9900
10" lbs of Torque	
5 to 1 gear Box	
Weight: 3.5 oz. (100g)	
Advantage® Shaver, No-Button.....	D9820
Forward Speed 500-10,000rpm	
Oscillate Speed 500-2,500cpm, Single- and Multi-turn Oscillate	
For use with Large Hub Shaver Blades and Burs	
For use with Advantage, E9000 and PowerPro® Consoles	
Weight: 15.8 oz. (450g)	
Advantage Shaver, Two-Button.....	D9824
Forward Speed 500-10,000rpm	
Oscillate Speed 500-2,500cpm, Single- and Multi-turn Oscillate	
For use with Large Hub Shaver Blades and Burs	
For use with Advantage, E9000 and PowerPro Consoles	
Weight: 15.8 oz. (450g)	
MicroChoice® Micro Shaver	MC9840
Forward Speed 300-6,000rpm	
Oscillate Speed 300-2,500cpm, Single- and Multi-turn Oscillate	
For use with Micro Hub Small Joint Blades and Burs	
For use with Advantage, E9000 and PowerPro Consoles	
Weight: 8.4 oz. (237g)	



All products may not be available in all markets.



Oval Bur

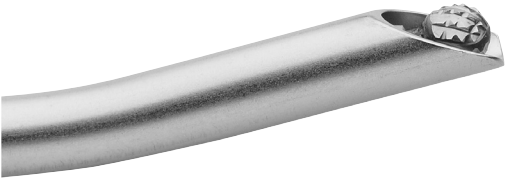

Polishing Bur

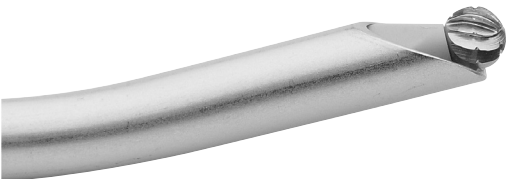

Spherical Bur

Signature Series™ Blades and Burs

- » Longer, stronger and designed exclusively for the hip joint
- » Available in pre-bent and straight styles
- » Unique curved bur designed to reach around femoral neck for more precise resection
- » All Blades and Burs have a 19cm working length. Blades run at 2,500rpm oscillate and 6,000rpm max and burs run at 12,000rpm max, 1 per box.
- » Blades and burs allow for resection of soft tissue and bone in deep, narrow joint spaces such as the hip.
- » Patented XtraSharp™ technology
- » Merlin® bendable technology
- » Concave and convex window configurations

Cat. No.

4.2mm HPS Great White®, Prebent Convex.....	HPS-CB01
4.2mm HPS Great White, Prebent Concave	HPS-CB02
4.2mm HPS FRR, Prebent Convex	HPS-CB03
4.2mm HPS FRR, Prebent Concave	HPS-CB04
4.2mm HPS Gator®, Prebent Convex	HPS-CB05
4.2mm HPS Gator, Prebent Concave.....	HPS-CB06
4.2mm HPS Ultracut®, Prebent Convex.....	HPS-CB07
4.2mm HPS Ultracut, Prebent Concave.....	HPS-CB08
4.5mm EL Hip Prebent Spherical Bur.....	HPS-HB01
4.5mm EL Hip Prebent Polishing Bur	HPS-HB02
4.0mm EL Hip Prebent Oval Bur	HPS-HB03
5.5mm EL Hip Prebent Spherical Bur.....	HPS-HB11
5.5mm EL Hip Prebent Polishing Bur	HPS-HB12
6.0mm EL Hip Prebent Oval Bur.....	HPS-HB13
4.2mm HPS Great White, Sterling	HPS-C001
4.2mm HPS Gator, Sterling.....	HPS-C002
4.2mm HPS FRR, Sterling	HPS-C003
4.2mm HPS Ultracut, Sterling	HPS-C004
4.5mm HPS Spherical Bur.....	HPS-H001
4.0mm HPS Oval Bur.....	HPS-H002
4.0mm HPS Pear Bur.....	HPS-H003
4.5mm HPS Polishing Bur	HPS-H004
4.5mm HPS Vortex® Bur	HPS-H005
5.5mm HPS Spherical Bur.....	HPS-H011
6.0mm HPS Oval Bur.....	HPS-H012
6.0mm HPS Pear Bur.....	HPS-H013
5.5mm HPS Polishing Bur	HPS-H014
6.0mm HPS Vortex Bur	HPS-H015
4.0/4.5mm EL Bur Sheath	HPS-S001
5.5/6.0mm EL Bur Sheath	HPS-S011

All products may not be available in all markets.

Signature Series™ Blades and Burs

4.2mm, Sterling, Shaver, Ultracut.....	EL9405
4.2mm, Merlin, Shaver, Cuda®, Bendable to 30°	EL9356
4.0mm, Sterling, Bur, Oval.....	EL9101
6.0mm, Sterling, Bur, Oval, 20° Reduced Hood	60VAL-EL-RH
4.2mm, Sterling, Shaver, Great White.....	EL9299
4.2mm, Sterling, Shaver, Great White, Pre-Bent 15°, Convex	EL9299D
4.2mm, Sterling, Shaver, Great White, Pre-Bent 15°, Concave	EL9299U
4.2mm, Sterling, Shaver, Gator	EL9263A
5.5mm, Sterling, Shaver, Gator	EL9260A
4.2mm, Sterling, Shaver, Full-Radius Resector, Pre-Bent 15°, Convex.....	EL9247D
4.2mm, Sterling, Shaver, Full-Radius Resector, Pre-Bent 15°, Concave.....	EL9247U
4.5mm, Sterling, Bur, Spherical, 20° Reduced Hood	EL9111RH
5.5mm, Sterling, Bur, Spherical, 20° Reduced Hood	55SPH-EL-RH

All products may not be available in all markets.



UltraGator™
Ideal for aggressive tissue and general bone resection.



UltraFRR™
Ideal for aggressive tissue and general bone resection.



UltraTiger™
Ideal for aggressive tissue and general bone resection.

For Use with the Following Handpieces:

For use with Ergo™ (D4240, D4200), Advantage® Turbo (D9924, D9920), and Advantage (D9824, D9820).

UltraGator™ Blade

	Cat. No.
3.5mm, UltraGator	DPS-C001
4.2mm, UltraGator	DPS-C002
5.5mm, UltraGator	DPS-C003

UltraFRR™ Blade

3.5mm, UltraFRR	DPS-C009
4.2mm, UltraFRR	DPS-C010
5.5mm, UltraFRR	DPS-C011

UltraTiger™ Blade

3.5mm, UltraTiger.....	DPS-C004
4.2mm, UltraTiger.....	DPS-C005

All products may not be available in all markets.



For Use with the Following Handpieces:

For use with Ergo™ (D4240, D4200), Advantage® Turbo (D9924, D9920), Advantage (D9824, D9820), and Apex® (C9820, C9824, C9828)

Great White® Blade

Cat. No.

Sterling®

6,000rpm Max., 13.0cm Working Length, 6 per Box

3.5mm, Large Hub, Sterling, Shaver, Great White	9399A
4.2mm, Large Hub, Sterling, Shaver, Great White	9299A
4.8mm, Large Hub, Sterling, Shaver, Great White	9297A
5.5mm, Large Hub, Sterling, Shaver, Great White	9599A

Pre-bent

Pre-Bent to 15°, 6,000rpm Max., 13.0cm Working Length, 6 per Box

4.2mm, Large Hub, Merlin®, Shaver, Great White	C9299M
--	--------

Merlin®

Bendable to 30° Max. 6,000rpm Max., 13.0cm Working Length, 6 per Box

3.7mm, Large Hub, Merlin, Shaver, Great White	37GRW-ME-ZZ
3.7mm, Large Hub, Merlin, Shaver, Great White Pre-Bent to 15°	37GRW-ME-PB
4.2mm, Large Hub, Merlin, Shaver, Great White	42GRW-ME-ZZ
4.2mm, Large Hub, Merlin, Shaver, Great White, Pre-Bent 15°	C9299P

ReAct®

6,000rpm Max., 13.0cm Working Length, 6 per Box

3.5mm, Large Hub, ReAct®, Shaver, Great White	35GRW-RA-ZZ
4.2mm, Large Hub, ReAct, Shaver, Great White	42GRW-RA-ZZ

Extended Length

6,000rpm Max., 19.0cm Working Length, 1 per Box

4.2mm, Large Hub, Merlin, Shaver, Great White, Pre-Bent 15°	EL9299U*
4.2mm, Large Hub, Merlin, Shaver, Great White, Pre-Bent 15°	EL9299D**
4.2mm, Large Hub, Merlin, Shaver, Great White	EL9299

Ultracut® Blade

Sterling®

6,000rpm Max., 13.0cm Working Length, 6 per Box

3.5mm, Large Hub, Sterling, Shaver Ultracut	35ULT-ST-ZZ
4.2mm, Large Hub, Sterling, Shaver, Ultracut	C9405
5.5mm, Large Hub, Sterling, Shaver, Ultracut	C9415

Pre-Bent

Pre-Bent to 15°, 6,000rpm Max., 13.0cm Working Length, 6 per Box

4.2mm, Large Hub, Sterling Shaver, Ultracut	42ULT-ZZ-MT
---	-------------

Extended Length

6,000rpm Max., 19.0cm Working Length, 1 per Box

4.2mm, Large Hub, Sterling, Shaver, Ultracut	EL9405
--	--------

Liberator Plus™ Blade

4.2mm, Large Hub, Sterling, Shaver, Ultracut, Liberator Plus	42ULT-LB-ST
--	-------------

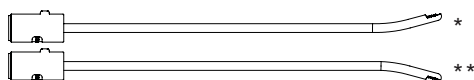

Great White®

The ultimate blade for aggressive soft tissue resection, including removal of the ACL stump.



Ultracut®

Excellent for all general debridement applications, including soft tissue and bone resection.



Liberator Plus™

Ideal for introduction, release and debridement of labral injuries.

All products may not be available in all markets.



Mako™

Ideal for procedures such as subacromial decompression, acromioplasty and any other procedure where soft tissue and/or bone cutting is desired.



Full-Radius Resector

For Use with the Following Handpieces:

For use with Ergo™ (D4240, D4200), Advantage™ Turbo (D9924, D9920), Advantage (D9824, D9820), and Apex® (C9820, C9824, C9828)

Mako™ Blade

Cat. No.

Sterling®

6,000rpm Max., 13.0cm Working Length, 6 per Box

4.2mm, Large Hub, Sterling, Shaver, Mako.....9298A

5.5mm, Large Hub, Sterling, Shaver, Mako..... C9298A

Full-Radius Resector

Sterling®

6,000rpm Max., 13.0cm Working Length, 6 per Box

3.5mm, Large Hub, Sterling, Shaver, Full–Radius Resector.....C9248

4.2mm, Large Hub, Sterling, Shaver, Full-Radius Resector9247A

4.8mm, Large Hub, Sterling, Shaver, Full-Radius ResectorC9245

5.5mm, Large Hub, Sterling, Shaver, Full-Radius Resector9246A

Pre-Bent

Pre-Bent to 15°, 6,000rpm Max., 13.0cm Working Length, 6 per Box

4.2mm, Large Hub, Sterling, Shaver, Full-Radius ResectorC9241M

Merlin®

Bendable to 30° Max. 6,000rpm Max., 13.0cm Working Length, 6 per Box

3.7mm, Large Hub, Merlin®, Shaver, Full-Radius ResectorP9375

3.7mm, Large Hub, Merlin, Shaver, Full-Radius Resector,
Pre-Bent to 15° 37FRR-ME-PB

4.2mm, Large Hub, Merlin, Shaver, Full-Radius ResectorP9376

4.2mm, Large Hub, Merlin, Shaver, Full-Radius Resector, Pre-bent to 15°C9241

4.8mm, Large Hub, Merlin, Shaver, Full-Radius Resector,
Bendable to 20° Max.....P9377

ReAct®

6,000rpm Max., 13.0cm Working Length, 6 per Box

3.5mm, Large Hub, ReAct, Shaver, Full-Radius Resector 35FRR-RA-ZZ

4.2mm, Large Hub, ReAct, Shaver, Full-Radius Resector 42FRR-RA-ZZ

Extended Length

6,000rpm Max., 19.0cm Working Length, 1 per Box

4.2mm, Large Hub, Merlin, Shaver, Full-Radius Resector
Pre-Bent to 15°, ConvexEL9247D

4.2mm, Large Hub, Merlin, Shaver, Full-Radius Resector
Pre-Bent to 15°, Concave EL9247U

Small Joint

6,000rpm Max., 8.0cm Working Length, 6/box

2.0mm, Large Hub, Sterling, Shaver, Full-Radius Resector C9943A

2.9mm, Large Hub, Sterling, Shaver, Full-Radius Resector C9944A

All products may not be available in all markets.

For Use with the Following Handpieces:

For use with Ergo™ (D4240, D4200), Advantage® Turbo (D9924, D9920), Advantage (D9824, D9820), and Apex® (C9820, C9824, C9828)

Gator™ Blade

Cat. No.

Sterling®

6,000rpm Max., 13.0cm Working Length, 6 per Box

3.5mm, Large Hub, Sterling, Shaver, Gator.....	C9264
4.2mm, Large Hub, Sterling, Shaver, Gator.....	9263A
4.8mm, Large Hub, Sterling, Shaver, Gator.....	C9262
5.5mm, Large Hub, Sterling, Shaver, Gator.....	9260A

Pre-Bent

Pre-Bent to 15°, 6,000rpm Max., 13.0cm Working Length, 6 per Box

4.2mm, Large Hub, Sterling, Shaver, Gator.....	C9266M
--	--------

Merlin®

Bendable to 30° Max. 6,000rpm Max., 13.0cm Working Length, 6 per Box

3.7mm, Large Hub, Merlin®, Shaver, Gator.....	P9365
3.7mm, Large Hub, Merlin, Shaver, Gator, Pre-Bent to 15°.....	37GTR-ME-PB
4.2mm, Large Hub, Merlin, Shaver, Gator.....	P9366
4.2mm, Large Hub, Merlin, Shaver, Gator.....	C9266
4.8mm, Large Hub, Merlin, Shaver, Gator,	P9367

ReAct®

6,000rpm max., 13.0cm working length, 6/box

3.5mm, Large Hub, ReAct, Shaver, Gator	35GTR-RA-ZZ
4.2mm, Large Hub, ReAct, Shaver, Gator	42GTR-RA-ZZ

Extended Length

6,000rpm Max., 19.0cm Working Length, 1 per Box

4.2mm, Large Hub, Sterling, Shaver, Gator.....	EL9263A
5.5mm, Large Hub, Sterling, Shaver, Gator.....	EL9260A

Small Joint

6,000rpm Max., 8.0cm Working Length, 6 per Box

2.0mm, Large Hub, Sterling, Shaver, Gator.....	C9960A
2.9mm, Large Hub, Sterling, Shaver, Gator.....	C9961A

Cuda® Blade

Sterling®

6,000rpm Max., 13.0cm Working Length, 6 per Box

3.5mm, Large Hub, Sterling, Shaver, Cuda.....	C9253
4.2mm, Large Hub, Sterling, Shaver, Cuda.....	C9254
4.8mm, Large Hub, Sterling, Shaver, Cuda.....	C9258
5.5mm, Large Hub, Sterling, Shaver, Cuda.....	C9255
3.7mm, Large Hub, Merlin, Shaver, Cuda.....	P9355

Pre-Bent

Pre-Bent to 15°, 6,000rpm Max., 13.0cm Working Length, 6 per Box

4.2mm, Large Hub, Sterling, Shaver, Cuda.....	C9256M
---	--------



Gator®

Ideal for aggressive meniscal trimming, joint debridement, plica and synovium removal, and bone resection.



Cuda®

All purpose aggressive blade. Ideal for extensive tissue removal.

All products may not be available in all markets.



Cuda®
All purpose aggressive blade. Ideal for extensive tissue removal.



Tiger®
Excellent for all general soft tissue debridement, especially menigeotomy and chondroplasty.



End Cutter
Useful for all general debridement applications.

For Use with the Following Handpieces:

For use with Ergo™ (D4240, D4200), Advantage® Turbo (D9924, D9920), Advantage (D9824, D9820), and Apex® (C9820, C9824, C9828)

Cat. No.

Merlin®

Bendable to 30° Max. 6,000rpm Max., 13.0cm Working Length, 6 per Box

3.7mm, Large Hub, Merlin, Shaver, Cuda, Pre-Bent to 15°.....	37CUD-ME-PB
4.2mm, Large Hub, Merlin, Shaver, Cuda	P9356
4.2mm, Large Hub, Merlin, Shaver, Cuda, Pre-bent 15°.....	C9256
4.8mm, Large Hub, Merlin, Shaver, Cuda, Bendable to 20° max.....	P9357

ReAct®

6,000rpm Max., 13.0cm Working Length, 6 per Box

3.5mm, Large Hub, ReAct®, Shaver, Cuda.....	35CUD-RA-ZZ
4.2mm, Large Hub, ReAct, Shaver, Cuda.....	42CUD-RA-ZZ

Extended Length

6,000rpm Max., 19.0cm Working Length, 1 per Box

4.2mm, Large Hub, Merlin, Shaver, Cuda Bendable to 30° max	EL9356
--	--------

Small Joint

6,000rpm Max., 8.0cm Working Length, 6 per Box

2.0mm, Large Hub, Sterling, Shaver, Cuda	C9951A
2.9mm, Large Hub, Sterling, Shaver, Cuda	C9952A

Tiger®

Sterling®

6,000rpm Max., 13.0cm Working Length, 6 per Box

3.5mm, Large Hub, Sterling®, Shaver, Tiger®	C9240
4.2mm, Large Hub, Sterling, Shaver, Tiger.....	C9242

Pre-Bent

Pre-Bent to 15°, 6,000rpm Max., 13.0cm Working Length, 6 per Box

4.2mm, Large Hub, Sterling, Shaver, Tiger.....	C9244M
--	--------

Merlin®

Bendable to 30° Max. 6,000rpm Max., 13.0cm Working Length, 6 per Box

3.7mm, Large Hub, Merlin, Shaver, Tiger, Pre-Bent to 15°	37TGR-ME-PB
--	-------------

ReAct®

6,000rpm Max., 13.0cm Working Length, 6 per Box

3.5mm, Large Hub, ReAct, Shaver, Tiger	35TGR-RA-ZZ
4.2mm, Large Hub, ReAct, Shaver, Tiger	42TGR-RA-ZZ

End Cutter

Sterling®

6,000rpm Max., 13.0cm Working Length, 6 per Box

3.5mm, Large Hub, Sterling, Shaver, End Cutter	C9283
4.2mm, Large Hub, Sterling, Shaver, End Cutter	C9284

For Use with the Following Handpieces:

For use with Ergo™ (D4240, D4200), Advantage® Turbo (D9924, D9920), Advantage (D9824, D9820), and Apex® (C9820, C9824, C9828)

Dragon® End Cutter

Sterling®
6,000rpm Max., 13.0cm Working Length, 6 per Box

	Cat No.
3.5mm, Large Hub, Sterling®, Shaver, Dragon End Cutter.....	C9290
4.2mm, Large Hub, Sterling, Shaver, Dragon End Cutter	C9291
5.5mm, Large Hub, Sterling, Shaver, Dragon End Cutter	C9292

Meniscus Cutter

Sterling®
6,000rpm Max., 13.0cm Working Length, 6 per Box

3.5mm, Large Hub, Sterling, Shaver, Meniscus Cutter.....	C9760
4.2mm, Large Hub, Sterling, Shaver, Meniscus Cutter.....	9761A
5.5mm, Large Hub, Sterling, Shaver, Meniscus Cutter.....	C9762

Slotted Whisker

Sterling®
6,000rpm Max., 13.0cm Working Length, 6 per Box

4.2mm, Large Hub, Sterling, Shaver, Slotted Whisker.....	C9274
5.5mm, Large Hub, Sterling, Shaver, Slotted Whisker.....	C9275



Dragon® End Cutter

A multi-purpose blade that's ideal for tough tissue resections like meniscus tears.



Meniscus Cutter

Useful for all meniscal trimming and joint debridement of the patella and trochlea chondromalacia.



Slotted Whisker

Non-aggressive, for debridement of the fine synovium, fatty tissue and articulating surfaces.

All products may not be available in all markets.



**With
Reduced
Hood**

Spherical

Useful for bony site preparation, cartilage and osteochondral debridement and osteophyte resection.



**With
Reduced
Hood**

Tapered

Excellent for shaping and resecting bone and cartilage during acromioplasty and notchplasty.



**With
Reduced
Hood**

Oval

Ideal for resecting bone and cartilage during acromioplasty and notchplasty.

For Use with the Following Handpieces:

For use with Ergo™ (D4240, D4200), Advantage® Turbo (D9924, D9920), Advantage (D9824, D9820), and Apex® (C9820, C9824, C9828)

Spherical Bur

Cat. No.

Sterling® 12,000rpm Max., 13.0cm Working Length, 6 per Box

3.5mm, Large Hub, Sterling®, Bur, Spherical	H9110
4.5mm, Large Hub, Sterling, Bur, Spherical	H9111
5.5mm, Large Hub, Sterling, Bur, Spherical	H9112
5.5mm, Large Hub, Sterling, Bur, Spherical, 20° Reduced Hood	H9112RH

Extended Length 12,000rpm Max., 19.0cm Working Length, 1 per Box

4.5mm, Large Hub, Sterling, Bur, Spherical, 20° Reduced Hood	EL9111RH
5.5mm, Large Hub, Sterling, Bur, Spherical 20° Reduced Hood	55SPH-EL-RH

Small Joint 6,000rpm Max., 8.0cm Working Length, 6 per Box

2.9mm, Large Hub, Sterling, Bur, Spherical	C9911A
--	--------

Tapered Bur

Sterling® 12,000rpm Max., 13.0cm Working Length, 6 per Box

4.0mm, Large Hub, Sterling, Bur, Tapered	H9121
4.0mm, Large Hub, Sterling, Bur, Tapered, 20° Reduced Hood,	H9121RH
6.0mm, Large Hub, Sterling, Bur, Tapered	H9122

Oval Bur

Sterling® 12,000rpm Max., 13.0cm Working Length, 6 per Box

4.0mm, Large Hub, Sterling, Bur, Oval	H9101
4.0mm, Large Hub, Sterling, Bur, Oval, Fully Hooded	40VAL-ST-FH
4.0mm, Large Hub, Sterling, Bur, Oval, 20° Reduced Hood,	H9101RH
4.0mm, Large Hub, Sterling, Bur, Oval, Left Helix	H9101LH
5.0mm, Large Hub, Sterling, Bur, Oval, 20° Reduced Hood	H9103RH
6.0mm, Large Hub, Sterling, Bur, Oval	H9102
6.0mm, Large Hub, Sterling, Bur, Oval, Left Helix	H9201LH

Extended Length 12,000rpm Max., 19.0cm Working Length, 1 per Box

4.0mm, Large Hub, Sterling, Bur, Oval	EL9101
6.0mm, Large Hub, Sterling, Bur, Oval, 20° Reduced Hood	60VAL-EL-RH

High speed bur operates at 12,000rpm with D9920 and D9924 shaver handpieces.

For Use with the Following Handpieces:

For use with Ergo™ (D4240, D4200), Advantage™ Turbo (D9924, D9920), Advantage (D9824, D9820), and Apex® (C9820, C9824, C9828)

Cyclone® Bur

Cat. No.

Sterling®

12,000rpm Max., 13.0cm Working Length, 6 per Box

4.5mm, Large Hub, Sterling®, Bur, Cyclone.....H9118

5.5mm, Large Hub, Sterling, Bur, CycloneH9119

Vortex® Router – Five Flutes

Sterling®

12,000rpm Max., 13.0cm Working Length, 6 per Box

4.5mm, Large Hub, Sterling, Router, Vortex, HoodedH9131

4.5mm, Large Hub, Sterling, Router, Vortex, Unhooded.....H9134

6.0mm, Large Hub, Sterling, Router, Vortex, HoodedH9132

Small Joint

6,000rpm Max., 8.0cm Working Length, 6 per Box (2 Flute Design)

2.9mm, Large Hub, Sterling, Bur, Vortex Router29VTX-SJ-ZZ

3.5mm, Large Hub, Sterling, Bur, Vortex Router35VTX-SJ-ZZ

Lightning®

Sterling®

12,000rpm Max., 13.0cm Working Length, 6 per Box

4.5mm, Large Hub, Sterling, Lighting.....H9133

Bur Sheaths

Sterling®

5.5 or 6.0mm Bur Sheath, Large Hub, Sterling,
for use with Inner Assembly of 5.5mm or 6.0mm Burs with 13cm
Working Length to Create Unhooded BurH9000

4.0 or 4.5mm Bur Sheath, Large Hub, Sterling,
for use with Inner Assembly of 4.0mm or 4.5mm Burs with 13cm
Working Length to Create Unhooded BurH9002

High speed bur operates at 12,000rpm with D9920 and D9924 shaver handpieces.



Cyclone®

Useful for aggressive bony site preparation, cartilage and osteochondral debridement, and osteophyte resection. Six cutting flutes.



Vortex® Router

Ultra-aggressive. Ideal for extensive bone and cartilage removal in the subacromial space. Five cutting flutes.



Lightning®

Ideal for procedures such as subacromial decompression, acromioplasty and any other procedure where both soft tissue and bone cutting is desired.

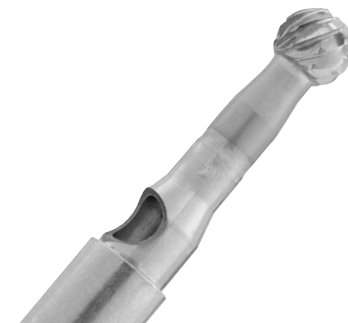

Bur and Sheath Purchased Separately

All products may not be available in all markets.



Great White®

The ultimate blade for aggressive soft tissue resection, including removal of the ACL stump.



Mako

Ideal for procedures such as subacromial decompression, acromioplasty and any other procedure where soft tissue and/or bone cutting is desired.



Great White® Blade

Cat. No.

Sterling®
5,000rpm Max., 13.0cm Working Length, 6 per Box

4.2mm, Micro Hub, Sterling®, Shaver, Great White M9299A

Mako Blade

Sterling®
5,000rpm Max., 13.0cm Working Length, 6 per Box

4.2mm, Micro Hub, Sterling, Shaver, Mako..... M9298A

For Use with the Following Handpieces:

C9840 and MC9840

Full-Radius Resector

Cat. No.

Sterling®

5,000rpm max., 6/box

2.0mm, Micro Hub, Sterling®, Blade, Full-Radius Resector, 7.6cm Working Length	C9940
2.9mm, Micro Hub, Sterling, Blade, Full-Radius Resector, 7.6cm Working Length	C9941
3.5mm, Micro Hub, Sterling, Blade, Full-Radius Resector, 7.6cm Working Length	C9942
3.5mm, Micro Hub, Sterling, Blade, Full-Radius Resector, 13.0cm Working Length	MC9248
4.2mm, Micro Hub, Sterling, Blade, Full-Radius Resector, 13.0cm Working Length,	M9247A

Merlin®

Bendable to 30° Max. 5,000rpm Max., 13.0cm Working Length, 6 per Box

4.8mm, Micro Hub, Sterling, Blade, Full-Radius Resector.....	MC9245
5.5mm, Micro Hub, Sterling, Blade, Full-Radius Resector.....	M9246A
4.2mm, Micro Hub, Merlin®, Blade, Full-Radius Resector, Pre-Bent 15°	MP9249
4.2mm, Micro Hub, Merlin, Blade, Full-Radius Resector.....	MP9376

Gator® Blade

Sterling®

5,000rpm Max., 6 per Box

2.0mm, Micro Hub, Sterling, Blade, Gator, 7.6cm Working Length.....	C9960
2.9mm, Micro Hub, Sterling, Blade, Gator, 7.6cm Working Length.....	C9961
3.5mm, Micro Hub, Sterling, Blade, Gator, 7.6cm Working Length.....	C9962
3.5mm, Micro Hub, Sterling, Blade, Gator, 13.0cm Working Length	MC9264
4.2mm, Micro Hub, Sterling, Blade, Gator, 13.0cm Working Length	M9263A

Merlin®

Bendable to 30° Max. 5,000rpm Max., 13.0cm Working Length, 6 per Box

4.8mm, Micro Hub, Sterling, Blade, Gator	MC9262
5.5mm, Micro Hub, Sterling, Blade, Gator	M9260A
4.2mm, Micro Hub, Merlin, Blade, Gator, Pre-Bent 15°	MP9269
4.2mm, Micro Hub, Merlin, Blade, Gator	MP9366



Full-Radius Resector

Excellent for all general debridement applications.



Gator®

Ideal for aggressive removal of synovium, soft tissue, cartilage and plica.

All products may not be available in all markets.



Cuda®
All-purpose aggressive blade. Ideal for extensive tissue removal.



Dragon® End Cutter
A multi-purpose blade that's ideal for tough tissue resections like meniscus tears.



Slotted Whisker
Non-aggressive, for debridement of the fine synovium, fatty tissue and articulating surfaces.

For Use with the Following Handpieces:

C9840 and MC9840

Cuda® Blade

Cat. No.

Sterling® 5,000rpm Max., 6 per Box

2.0mm, Micro Hub, Sterling®, Blade, Cuda, 7.6cm Working Length.....	C9950
2.9mm, Micro Hub, Sterling, Blade, Cuda, 7.6cm Working Length.....	C9951
3.5mm, Micro Hub, Sterling, Blade, Cuda, 7.6cm Working Length.....	C9952
3.5mm, Micro Hub, Sterling, Blade, Cuda, 13.0cm Working Length	MC9253
4.2mm, Micro Hub, Sterling, Blade, Cuda, 13.0cm Working Length.....	MC9254

Merlin® Bendable to 30° Max. 5,000rpm Max., 13.0cm Working Length, 6 per Box

4.8mm, Micro Hub, Sterling, Blade, Cuda.....	MC9258
5.5mm, Micro Hub, Sterling, Blade, Cuda.....	MC9255
4.2mm, Micro Hub, Merlin®, Blade, Cuda, Pre-Bent 15°	MP9259
4.2mm, Micro Hub, Merlin, Blade, Cuda.....	MP9356

Dragon® End Cutter

Sterling® 5,000rpm Max., 13.0cm Working Length, 6 per Box

3.5mm, Micro Hub, Sterling, Blade, Dragon, End Cutter.....	MC9290
4.2mm, Micro Hub, Sterling, Blade, Dragon, End Cutter.....	MC9291
5.5mm, Micro Hub, Sterling, Blade, Dragon, End Cutter.....	MC9292

Slotted Whisker

Sterling® 5,000rpm Max., 6 per Box

2.9mm, Micro Hub, Sterling, Blade, Slotted Whisker, 7.6cm Working Length	C9981
4.2mm, Micro Hub, Sterling, Blade, Slotted Whisker, 13.0cm Working Length	MC9274

For Use with the Following Handpieces:

C9840 and MC9840

Spherical Bur

Cat. No.

Sterling®

5,000rpm Max., 6 per Box

- 2.9mm, Micro Hub, Sterling®, Bur, Spherical, 7.6cm Working Length,C9911
- 3.5mm, Micro Hub, Sterling, Bur, Spherical, 7.6cm Working Length C9912
- 4.5mm, Micro Hub, Sterling, Bur, Spherical, 13.0cm Working Length..... MH9111
- 5.5mm, Micro Hub, Sterling, Bur, Spherical, 13.0cm Working Length..... MH9112

Oval Bur

Sterling®

5,000rpm Max., 13.0cm Working Length, 6 per Box

- 6.0mm, Micro Hub, Sterling, Bur, OvalMH9102
- 6.0mm, Micro Hub, Sterling, Bur, Oval, Left Helix MC9106

Vortex® Router - Two Flutes

Sterling®

Hooded, 5,000rpm Max., 6 per Box

- 2.9mm, Micro Hub, Sterling, Router, Vortex, 7.6cm Working Length C9990
- 3.5mm, Micro Hub, Sterling, Router, Vortex, 7.6cm Working Length C9991
- 4.5mm, Micro Hub, Sterling, Router, Vortex, 13.0cm Working Length..... MH9131
- 6.0mm, Micro Hub, Sterling, Router, Vortex, 13.0cm Working Length..... MH9132



Spherical

Useful for bony site preparation, cartilage and osteochondral debridement, and osteophyte resection.



Oval

Ideal for resecting bone and cartilage during acromioplasty and notchplasty.



Vortex® Router – Two Flute

Ultra-aggressive. Ideal for extensive bone and cartilage removal. Two cutting flutes.

All products may not be available in all markets.

FLUID MANAGEMENT PRODUCTS

24k® Irrigation System Console

Controlling inflow, outflow and shaver suction, the 24k pump will manage the arthroscopy fluid needs of the most challenging surgeries. The 24k Pump can also work as a simple inflow-only pump. Whatever your needs, the 24k Pump can deliver.

Performance Specifications:

- » Maximum Flow Rate 2 liters per minute
- » Set Pressure Ranges 10-150 mmHg in 5 mmHg increments

Technical Specifications:

- » Weight: 10.3 lbs (4.6 Kg)
- » Dimensions: 14.0"w x 7.1"h x 15.9"d (35.6cm w x 18.0cm h x 40.4cm d)
- » Voltage: 100-240 VAC

Cat. No.

24k® Irrigation System Console24k

24k Autoclavable Remote Control

The C8115 is a fully autoclavable remote for the 24k Pump. The C8115 is a 6 button, 9 function remote that allows control of pressure, flow rates, suction rates, tamponade function, Clearfield function, shaver declog function, drain function and run and stop.

24k Autoclavable Remote ControlC8115

24k Interface Cable

The 24K Interface Cable provides a direct connection between the D4000/D4000A console and the 24K pump, allowing the 24K pump to control suction through the shaver handpiece.

24K Interface Cable D4024

24k Shaver Sensor

The 24k900 Shaver Sensor connects to the 24k Pump and clips to the cable of any shaver handpiece allowing the 24k Pump to control suction through the shaver handpiece.

24k Shaver Sensor24k900

24k and 10k® Arthroscopic Tubing

24k100 Outflow, Shaver Suction Tube Set

This arthroscopic tube set allows the 24k Pump to control the outflow and shaver suction. This tube set must be used in conjunction with the 10k100, 10k150 or EcoFlow Day-Use Tube Sets24k100

24kTIPS Tube Set

This tube set allows for the use of True Intraarticular Pressure Sensing. This tube set can only be used in conjunction with Pressure Sensing Scope Sheaths or Pressure Sensing Cannulas. Only used with 24k Pump..... 24kTIPS

10k100 Arthroscopic Inflow-Only Tube Set

Arthroscopic inflow-only tube set with a luer lock connection can be used with the 24k Pump or the 10k Pump. Can be used in conjunction with 24k100 to provide to the 24k Pump, inflow, outflow and shaver suction 10k100

10k150 Arthroscopic Inflow-Only Tube Set with Suction Tube

Arthroscopic inflow-only tube set with an extra shaver suction line for wall suction. The shaver suction line can be peeled off for use with shaver handpiece or independent source suction. Can be used with the 24k Pump or 10k Pump 10k150



24k® Irrigation System Console



24k Autoclavable Remote Control



24k Shaver Sensor

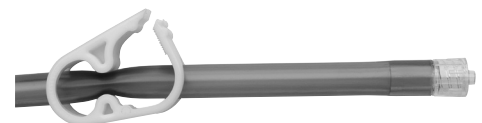

10k100 Arthroscopic Inflow-Only Tube Set

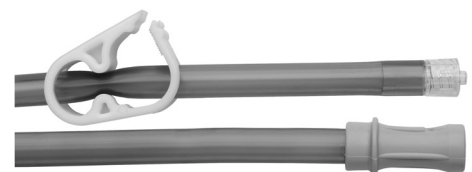

10k150 Arthroscopic Inflow-Only Tube Set with Suction Tube

All products may not be available in all markets.

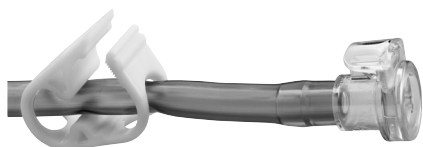

10k100D Arthroscopic Inflow-Only Tube Set with Colder Adapter

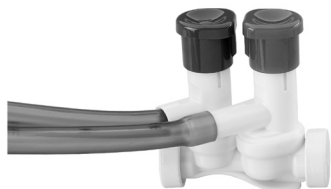

10k500 Laparoscopic Tube Set with-out Cannula



10k505 Laparoscopic Tube Set with Fixed Cannula



10k600 Arthroscopic Day-Use Pump Inflow Tube Set



10k605 Arthroscopic Single-Use Patient Inflow Tube Set

10k100D Arthroscopic Inflow-Only Tube Set with Colder Adapter

Cat. No.

Arthroscopic inflow-only tube set with a Colder adapter can be fitted to a Dyonics scope sheath or cannula. This tube set can be used with the 24k® Pump or 10k® Pump10k100D

24k® and 10k® Laparoscopic Tubing

10k500 Laparoscopic Tube Set with-out Cannula

Laparoscopic suction/irrigation handpiece and tube set interfaces with selected CONMED Endoscopy cannulas. This tube set can be used with the 24k Pump or the 10k Pump 10k500

10k505 Laparoscopic Tube Set with Fixed Cannula

Laparoscopic suction/irrigation handpiece and tube set with a fixed 5mm x 33mm cannula. This tube set can be used with the 24k Pump or the 10k Pump 10k505

EcoFlow® Day-Use Tubing System

10k600 Arthroscopic Day-Use Pump Inflow Tube Set

This arthroscopic inflow tube set will stay on the face of the 10k pump or 24k pump for one surgical day. Must be used with the 10k605. 10k600

10k605 Arthroscopic Single-Use Patient Inflow Tube Set

This arthroscopic inflow tube set is a single-use only tube set for the 10k pump or 24k pump. Must be used with the 10k600. 10k605

All products may not be available in all markets.

10k® Irrigation System Console

Setup and priming are faster and easier than any arthroscopy pump system in the world. The 10k® pump can be used in arthroscopy and laparoscopy.

Performance Specifications:

- » Maximum Flow: 2000ml/min
- » Set Pressure Ranges: 30 – 150mmHg

Technical Specifications:

- » Weight: 7 lbs
- » Dimensions: 7.75"w x 6.5"h x 8"d
- » Voltage: 100-240V
- » Includes: 10' (3M) power cord

Cat. No.

10k Irrigation System Console..... 10k

10k Autoclavable Remote Control

The C7115 provides full control of the 10K console from within the sterile field.

- » Flow Control
- » Pressure Control
- » Tamponade Assist

10K Autoclavable Remote Control C7115

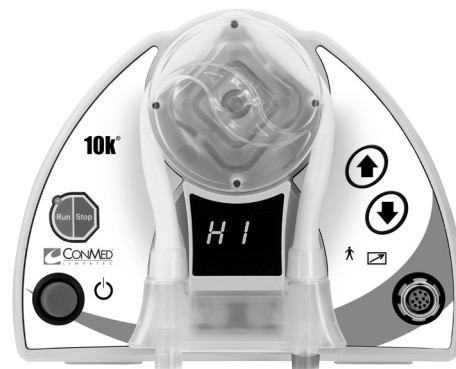

10k® Irrigation System Console



10K Autoclavable Remote Control

All products may not be available in all markets.



Sterilizable Hand Control

87k™ Autoclavable Remote with Detachable Cord

The 87k Autoclavable Remote has a detachable cord for increased reliability. The remote allows for finger tip control of:

- » Flow rate
- » Pressure setting
- » Run/stop drain from within the sterile field

Cat. No.

Sterilizable Hand Control W/Detachable 15' (4.6m) Cord87012



87k Arthroscopy Cassette Tubing Set

87k™ Arthroscopy Pump Cassette Tubing Set

- » Tubing sets are packaged sterile, three units per box
- » Spike Line with two bag spikes for Irrigation Supply 4' (1.2m)
- » Inflow Line with Luer-lock Connection 10' (3m)
- » Used with 87K Arthroscopy Pump
- » **Latex free**

87k Arthroscopy Cassette Tubing Set87100



83000 Arthroscopy Tubing Set

83000 Arthroscopy Pump Tubing Set

- » Tubing sets are packaged sterile, five units per box
- » Inflow Line with Luer-lock Connection 10' (3m)
- » Used with 83000 Arthroscopy Pump
- » **Contains Latex**

83000 Arthroscopy Tubing Set83100

All products may not be available in all markets.

Apex® Universal Irrigation Accessories

The Apex® Universal Irrigation Console, C7100A, is a microprocessor-based fluid management system designed for safe control of intra-articular irrigation and distension during arthroscopic procedures.

Apex® Autoclavable Remote Control

- » Cable length 10' (3m)
- » Replaceable buttons
- » Replaceable door

Cat. No.

Apex Autoclavable Remote Control.....C7115

Apex® One-Connection Disposable Tubing Set

Tubing sets are packaged sterile, eight units per box.

- » The tubing set material is latex free, flexible polyvinyl chloride
- » Inflow line with Luer-lock connection 11' (3.4m)
- » Spike line with two bag spikes for irrigation supply 6' (1.8m)
- » Integrated outflow line providing control of fluid flow through remote or front panel controls

Apex One-Connection Disposable Tubing SetC7120

Apex® Two-Connection Disposable Tubing Set

Tubing sets are packaged sterile, eight units per box.

- » The tubing set material is latex free, flexible polyvinyl chloride
- » Inflow line with Luer-lock connection 11' (3.4m)
- » Spike line with four bag spikes for irrigation supply 6' (1.8m)
- » Integrated outflow line providing control of fluid flow through remote or front panel controls

Apex Two-Connection Disposable Tubing Set.....C7122



Apex® Autoclavable Remote Control



Apex One-Connection Disposable Tubing Set



Apex Two-Connection Disposable Tubing Set

All products may not be available in all markets.



Apex® Autoclavable Remote Control

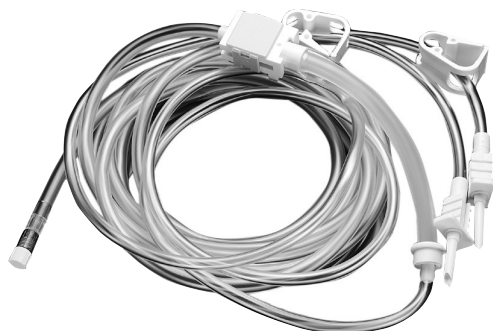

Disposable Tubing Set

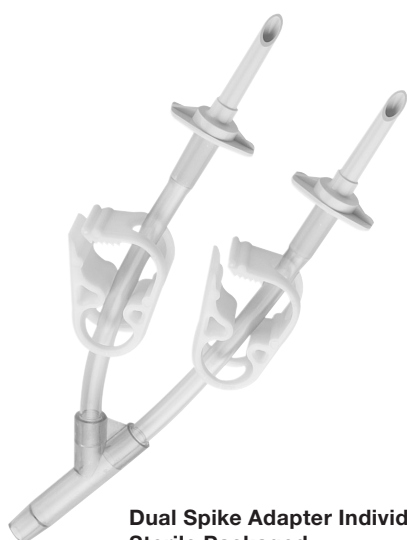

Dual Spike Adapter Individual Sterile Packaged

Irrigation Console Accessories

The irrigation console, C7050, is designed as a simple, easy-to-use fluid irrigation system providing increased performance that is usually found in larger, more complex pump systems.

Cat. No.

Apex® Autoclavable Remote Control C7115

Disposable Tubing Set For C7050 Irrigation Console

Tubing sets are packaged sterile, ten units per box. Each tubing set includes the following:

- » Latex free material, flexible polyvinyl chloride and silicone
- » Inflow line with Luer-lock connection 10' (3m)
- » Spike line with two bag spikes for irrigation supply 5'. (1.5m)

Disposable Tubing Set C7052

Power Cord 10' (3m)

115 Volt C7104

220 Volt C7105

Dual Spike Adapter Individual Sterile Packaged (10 per Box) 87101

All products may not be available in all markets.

Gravity Irrigation Two-Spike and Four-Spike Disposable Tubing Set

The Two-Spike and Four-Spike Gravity tubing set is compatible with existing scope/inflow sheaths or cannulas. No special sheaths or cannulas are required. Extra large tubing diameters maintain high flow rates under the most demanding conditions.

Tubing sets are packaged sterile, single use, eight per box. Each tubing set includes the following:

- » **Latex free**, flexible polyvinyl chloride
- » Inflow line with flexible connection 11' (3.4m)
- » Spike line with two bag spikes for irrigation supply
- » Inflow clamp within sterile field to control flow rates

Cat. No.

Gravity Irrigation Disposable Tubing Set, Two-Spike	C7110
Gravity Irrigation Disposable Tubing Set, Four-Spike.....	C7111

Small Joint Tubing and Cannula Set

Cannula and tubing features:

- » Beveled atraumatic tip
- » Barbed design to prevent slippage
- » Syringe injection port
- » Inside diameter designed to maintain correct flow rate for clear field of vision and proper joint distension
- » Series of one-way valves to prevent backflow
- » Convenient hand pump to purge visual field
- » Latex free, polyvinyl chloride material
- » Packaged sterile, single-use, five per box

Set includes:

- » 2mm O.D. inflow cannula with matching needle
- » 60" inflow tubing with one-way valves
- » 3cc syringe
- » Landmark probe

Small Joint Tubing and Cannula Set	9350
--	------



Four-Spike Gravity Irrigation Disposable Tubing Set

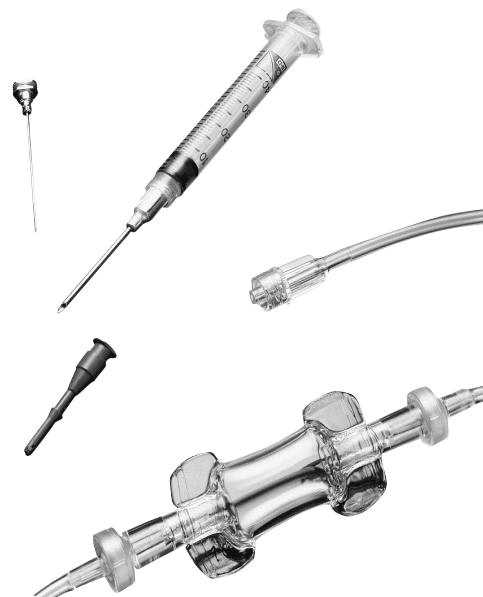

Small Joint Tubing and Cannula Set

All products may not be available in all markets.



PuddleVac® Floor Suction Device

PuddleVac® Floor Suction Device

The PuddleVac floor suction device provides a simple solution to a problem often encountered during procedures utilizing fluid distension media – pools of fluid on the operating room floor. Suction should be set at a standard hospital suction level of approximately 300 mmHg. The PuddleVac is easily moved wherever it is needed. A single PuddleVac can collect an average of 700ml of fluid per minute.

Cat. No.

PuddleVac Floor Suction Device, Single-Use (30 per Box)9321

ESA ELECTROSURGICAL ARTHROSCOPY PRODUCTS

All products may not be available in all markets.

Edge™ Bipolar Arthroscopic Radiofrequency System



Edge™ Arthroscopic Energy Generator



Edge™ Arthroscopic Energy Foot Control



Edge™ Arthroscopic Energy Wireless Foot Control



Edge™ Arthroscopic Energy 90° Probe with Suction



Edge™ Arthroscopic Energy 50° Probe with Suction



Edge™ Arthroscopic Energy 30° Probe

Edge™ Bipolar Arthroscopic RF System

Edge™ Arthroscopic Energy Generator

The Edge System is a organically designed solution for both bipolar and monopolar radio frequency (RF) arthroscopic ablation and coagulation of soft tissue. The Edge System consists of a generator, (3) bipolar probes and optional wired or wireless foot controls.

Cat. No.

Arthroscopic Energy Generator.....	AES-1
Arthroscopic Energy Foot Control.....	AES-FC
Arthroscopic Energy Wireless Foot Control.....	AES-WFC
Arthroscopic Energy Foot Control Extension.....	AES-FCE
110v Power Cord, 10ft.....	C-7104
220v Power Cord, 10ft.....	C-7105

Edge™ Disposable Probes

These bipolar probes feature integrated handpiece control and temperature monitoring capability. Robust suction is included in the 90 and 50 degree models. In addition, the customized connector contains a memory chip, which when plugged into the generator, automatically sets the optimized generator setting to ensure the best device performance.

Arthroscopic Energy 90° Probe with Suction for Shoulder Procedures.....	AES-90SC
Arthroscopic Energy 50° Probe with Suction for Knee Procedures.....	AES-50S
Arthroscopic Energy 30° Probe for Extremities and Small Joint Procedures.....	AES-30

All products may not be available in all markets.

LightWave®, LightWave Foot Control and LightWave Suction Ablators

The LightWave® design incorporates a one-piece molded handle, which is plugged directly into the monopolar port of a standard electrosurgical generator. The LightWave Foot Control utilizes a generator adapter to connect to the monopolar “foot control” port of the generator. The LightWave Suction Ablator features hand controls, adjustable roller clamp suction control and a universal suction tubing adapter.

Cat. No.

3.2mm dia. x 150mm Length, 90° Angle	IA-2379
3.2mm dia. x 150mm Length, 90° Angle, Foot Control.....	IA-2379-FC
4.0mm dia. x 135mm Length, 90° Angle, Suction.....	IA-2000-S
4.0mm dia. x 165mm Length, 90° Angle, Suction.....	EL-2000-S

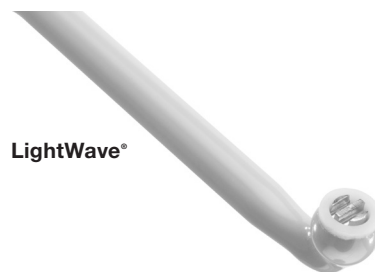

All products may not be available in all markets.

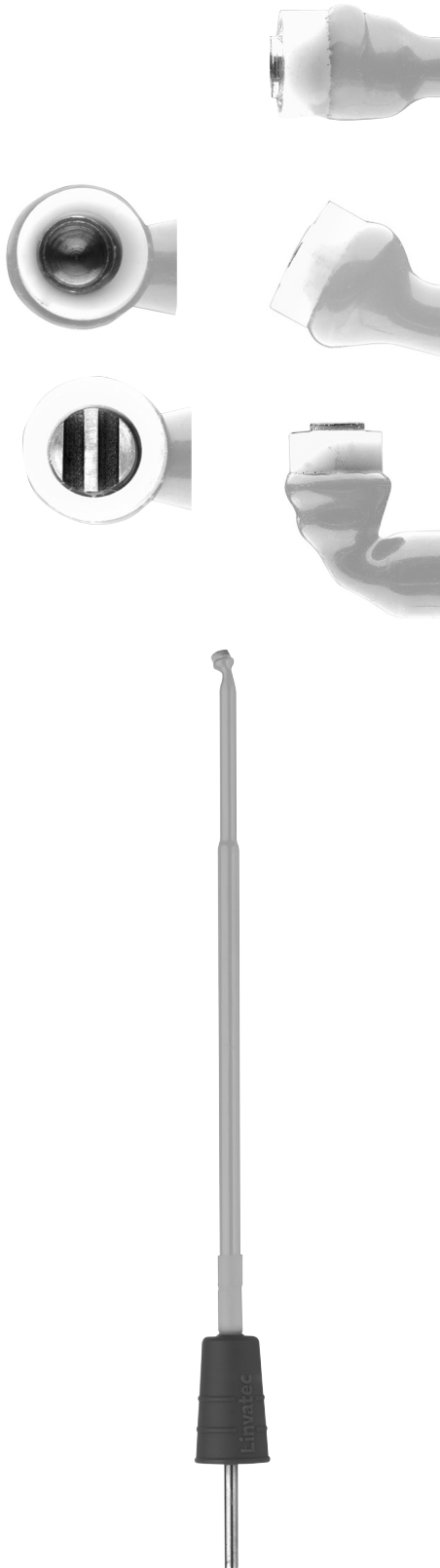

UltrAblator® – Standard

2.5mm diameter

- » Ideal for chondroplasty and hyaline cartilage
- » Ideal for meniscectomy

60mm long

	Cat. No.
30° Angle	ESA-5234

110mm long

30° Angle	ESA-5236
90° Angle	ESA-5296

3.2mm diameter

- » Ideal for subacromial decompression and notchplasty

110mm long

30° Angle	ESA-5336
90° Angle	ESA-5396

UltrAblator 3 Rib – Aggressive

3.2mm diameter

- » Ideal for subacromial decompression and notchplasty

110mm long

30° Angle	ESA-5333
90° Angle	ESA-5339

130mm long

30° Angle	ESA-5373
90° Angle	ESA-5379

Sold 5 per Box. Not for use in procedures where non-electrically conductive fluid media is used.

All products may not be available in all markets.

Concept® Ablator

3.2mm diameter

» Ideal for subacromial decompression and notchplasty

107mm long

	Cat. No.
90° Angle 5 per Box.....	ESA-5196

158mm long

30° Angle 5 per Box.....	ESA-5130
90° Angle 5 per Box.....	ESA-5190
30° Angle Basic Kit.....	ESA-5130B
90° Angle Basic Kit.....	ESA-5190B
30° Angle Mini Kit.....	ESA-5130M
90° Angle Mini Kit.....	ESA-5190M

Basic Kits

Basic Kits include an ESA electrode in the style of your choice, hand switching pencil with a three-prong plug and safety holster.

Mini-Kits

Mini-Kits include an ESA electrode in the style of your choice, hand switching pencil with a three-prong plug, safety holster and dispersive patient pad.

Heatwave®

2.3mm Diameter

- » Ideal for thermal capsular shift
- » Ideal for ACL modification

130mm Long

Bendable Tip.....	CS-023
-------------------	--------

60mm Length

Flex-Tip (Bendable Tip Design).....	CS-024
-------------------------------------	--------



All products may not be available in all markets.



Soft Tissue Electrode, Hook Design

Indicated for Subcutaneous Lateral Release (SLR) using a lateral approach, removal of plica and the coagulation of bleeders following a synovectomy.

111mm (4.4") Hook Electrode

Cat. No.

Basic Kit 9730BA

165mm (6.5") Hook Electrode

Basic Kit 9731BA

Mini-Kit 9721A



Meniscectomy Electrode, Standard Design

The tip is angled at 90° for resecting the anterior horn of bucket handle tears or any tear where exposure is difficult. Traction on the fragment is not required for effective cutting action.

111mm (4.4")

Basic Kit 9724BA

Mini-Kit 9726A

165mm (6.5")

Basic Kit 9735BA

Mini-Kit 9725A

Electrode only (5 per Box) C5010A

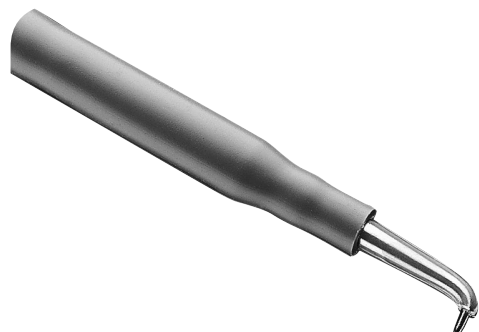

Meniscectomy Electrode, 90° Angled Tip

The tip is angled at 90° to allow easier access to the posterior compartment of the knee.

165mm (6.5")

Basic Kit 9737BA

Mini-Kit 9736A

Electrode only (5 per Box) C5011A

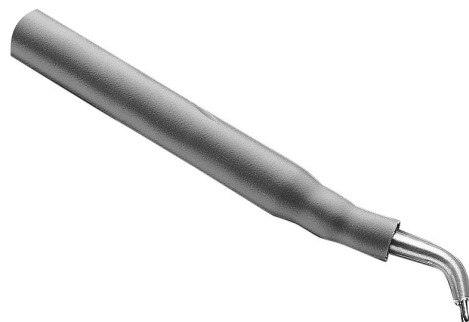

Meniscectomy Electrode, 45° Angled Tip

The tip is angled at 45° to allow easier access to the posterior compartment of the knee.

165mm (6.5")

Basic Kit 9738BA

All products may not be available in all markets.

Meniscectomy Electrode, Loop Design

Indicated for resection of many types of meniscal tears. The loop electrode facilitates cutting and coagulation of meniscal tissue. The distance between electrode tips is approximately 4.5mm.

165mm (6.5")

	Cat. No.
Basic Kit	9734BA
Mini-Kit	9733A



Acromioplasty Electrode

Indicated for use in the shoulder when performing an acromioplasty. The tip is insulated to protect unaffected soft tissue.

165mm (6.5")

Basic Kit	9801BA
Mini-Kit	9802A
Electrode only (5 box)	C5012A



Small Joint Electrode, 90° Angled Tip

For procedures of the wrist and other small joints. The 90° angled tip is effective for the cutting and hemostasis of soft tissue encountered during surgery.

75mm (2.9")

Basic Kit	8323BA
Mini-Kit	8322A



All products may not be available in all markets.

ENDOSCOPIC SYSTEMS

Arthroscopes

CONMED Autoclavable Arthroscopes offer excellent optical performance with state-of-the-art optical systems. Sapphire lenses ensure durability, decreasing costly repairs.

1.9mm Autoclavable Arthroscope

» Working Length 60mm

	Eyecup	Cartridge
1.9mm 0°	T1900	T1901
1.9mm 30°	T1930	T1931

Sheath System for 1.9mm Arthroscope

	Cat. No.
2.8mm Sheath	C3101
Blunt Obturator	C3102
Conical Obturator	C3103
Sharp Trocar	C3104

2.5mm Autoclavable Arthroscope

» Working Length 72mm

	Eyecup	Cartridge
2.5mm 0°	T2500	T2501
2.5mm 30°	T2530	T2531
2.5mm 70°	T2570	T2571

Sheath System for 2.5mm Arthroscope

	Cat. No.
3.5mm Double Stopcock Sheath Kit	C3252
3.5mm Double Stopcock Sheath Kit with 30° tip	C3252-30
Blunt Obturator	C3253
Conical Obturator	C3254
Sharp Trocar	C3255



1.9mm Autoclavable Arthroscope



2.5mm Autoclavable Arthroscope

All products may not be available in all markets.



QuickLatch® Autoclavable 2.9mm Arthroscope

QuickLatch® Autoclavable 2.9mm Arthroscope

CONMED's 2.9mm Arthroscope offers superior optical performance in a smaller package than a standard 4mm arthroscope. Features include:

- » 2.9mm outside diameter
- » Working length 152mm
- » 100° field-of-view
- » 0°, 30°, 45° and 70° angle-of-view
- » Equivalent light transmission and image size to a 4mm arthroscope
- » Increased depth-of-field and less distortion compared to competitive 4mm arthroscopes
- » Increased durability with new proprietary sheath system

	Eyecup	Cartridge
2.9mm 0°	T2900	T2901
2.9mm 30°	T2930	T2931
2.9mm 45°	T2944	T2945
2.9mm 70°	T2970	T2971

QuickLatch Sheath System for 2.9mm Arthroscope

A proprietary scope-sheath interface offers better protection of the arthroscope and increased flow efficiency.

- » Smaller outside diameter allows for better maneuverability
- » Scope-sheath interface ensures excellent tip protection
- » Ease-of-use increases efficiency



QuickLatch High Flow Double Stopcock Sheath

	Cat. No.
4.0mm Small Joint Single Stopcock Sheath	T4031
4.0mm Small Joint Double Stopcock Sheath	T4032
4.7mm Arthroscopy Single Stopcock Sheath	T4731
4.7mm Arthroscopy Double Stopcock Sheath	T4732
5.2mm High Flow Single Stopcock Sheath	T4931
5.2mm High Flow Double Stopcock Sheath	T4932
5.2mm Pressure Sensing Single Stopcock Sheath System	T5131
5.2mm Pressure Sensing Double Stopcock Sheath System	T5132
Blunt Obturator	T4901
Conical Obturator	T4902
Sharp Trocar	T4903
Sheath Body O-ring (Replacement), Qty. 2	T4904
Stopcock O-ring (Replacement), Qty. 4	T4908
11" Switching Stick	T4906-11
14" Switching Stick	T4906
Arthroscopic Portal Rod	T4907
Stopcock Locking Nut	T4905
Single Stopcock Bridge	T4911
Double Stopcock Bridge	T4912
Stopcock Lock	T4914
Pressure Sensing Bridge Adapter	T4910
Pressure Sensing Single Stopcock Assembly	T5101
Pressure Sensing Double Stopcock Assembly	T5102
Pressure Sensing Outer Tip Assembly	T5103
Pressure Sensing Stopcock O-ring	T5104
Pressure Sensing Outer Tip Assembly O-ring	T5105
Arthroscopy Sheath Body (Replacement)	T4730
Arthroscopy High Flow Sheath Body (Replacement)	T4930
Pressure Sensing Sheath Body	T5130

All products may not be available in all markets.

HD Autoclavable 4mm Arthroscope

CONMED's 4mm HD Arthroscope features state-of-the-art optics with an innovative scope-sheath interface.

» Working length 170mm

	Eyecup	Cartridge
4mm 0°	HD4000	HD4001
4mm 30°	HD4300	HD4301
4mm 70°	HD4700	HD4701

QuickLatch® Sheath System for 4mm Arthroscope

Proprietary scope-sheath interface offers ease-of-use with better protection of the arthroscope and increased flow efficiency.

» 5.5mm and 5.9mm Outside diameter sheaths

» Scope-sheath interface increases durability and provides excellent tip protection of the arthroscope

	Cat. No.
5.5mm Arthroscopy Sheath Kit	
Single Stopcock.....	QL5531
Double Stopcock.....	QL5532
5.9mm High Flow Sheath Kit	
Single Stopcock.....	QL6131
Double Stopcock.....	QL6132
5.9mm Pressure Sensing Sheath Kit	
Single Stopcock.....	QL6231
Double Stopcock.....	QL6232
Switching Sticks	
11" Switching Stick	T4906-11
14" Switching Stick	T4906
Arthroscopic Portal Rod.....	T4907
QuickLatch® Stopcock Lock	T4914

DoubleLatch® Bridge System

Single Stopcock DoubleLatch® Bridge.....	DL6111
Double Stopcock DoubleLatch Bridge.....	DL6112
5.8mm DoubleLatch Cannula with Valve	DL5801V
5.8mm DoubleLatch Retaining Cannula with Valve.....	DL5802V
5.8mm DoubleLatch Conical Obturator	DL5804
10 Replacement Seals for DoubleLatch Cannulas	DL1008
Replacement Cannula Seal Cap.....	DL1009
Seal Cap Installation and Removal Tool	DL1010
4.6mm DoubleLatch Cannula	DL4601
4.6mm DoubleLatch Cannula with Valve	DL4601V
4.6mm DoubleLatch Retaining Cannula	DL4602
4.6mm DoubleLatch Retaining Cannula with Valve.....	DL4602V
4.6mm DoubleLatch Trocar	DL4603
4.6mm DoubleLatch Conical Obturator	DL4604
4.6mm DoubleLatch Cannulated Obturator.....	DL4605
4.6mm DoubleLatch Fenestrated Cannula.....	DL4607
4.6mm DoubleLatch Fenestrated Cannula with Valve.....	DL4607V
5.8mm DoubleLatch Cannula	DL5801
5.8mm DoubleLatch Retaining Cannula	DL5802



HD Autoclavable 4mm Arthroscope

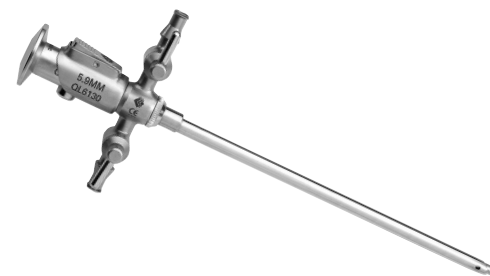

QuickLatch® Sheath System for 4mm Arthroscope

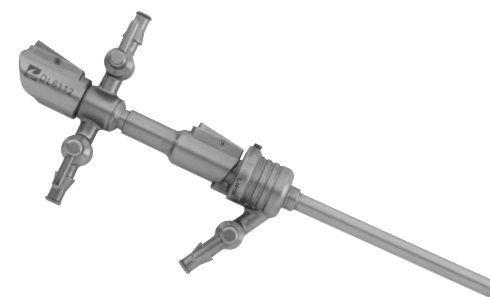

DoubleLatch Bridge System

All products may not be available in all markets.

Autoclavable Arthroscopes and Sheath Systems

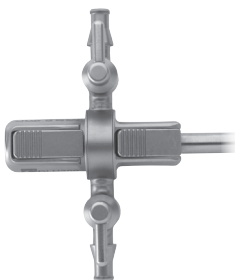

DoubleLatch® Hip Double Stopcock



DoubleLatch Hip Cannula Straight



DoubleLatch Hip Cannulated Obturator



4.6mm DoubleLatch Hip Cannulated Obturator with Handle



QuickLatch® Bridge Systems for 4mm Arthroscope

- Pressure Sensing 5.9mm Sheath Body
- Pressure Sensing Double Stopcock Assembly
- Pressure Sensing Bridge Adapter

DoubleLatch® Bridge System

	Cat. No.
5.8mm DoubleLatch Trocar	DL5803
5.8mm DoubleLatch Cannulated Obturator.....	DL5805
5.8mm DoubleLatch Fenestrated Cannula.....	DL5807
5.8mm DoubleLatch Fenestrated Cannula with Valve.....	DL5807V
Reverse Single Stopcock DoubleLatch Bridge.....	DLR6111
Reverse Double Stopcock DoubleLatch Bridge.....	DLR6112
DoubleLatch Hip Arthroscopy Bridge System	
Single Stopcock DoubleLatch Hip Bridge.....	DLH100
Double Stopcock DoubleLatch Hip Bridge.....	DLH200
Double Stopcock DoubleLatch Reverse Hip Bridge.....	DLH202
4.6mm DoubleLatch Hip Conical Obturator.....	DLH460
4.6mm DoubleLatch Hip Cannulated Obturator.....	DLH461
4.6mm DoubleLatch Hip Cannulated Obturator with Handle.....	HPS-H46
4.6mm DoubleLatch Hip Cannula Straight.....	DLH462
4.6mm DoubleLatch Hip Cannula Fenestrated.....	DLH463
5.8mm DoubleLatch Hip Conical Obturator.....	DLH580
5.8mm DoubleLatch Hip Cannulated Obturator.....	DLH581
5.8mm DoubleLatch Hip Cannulated Obturator with Handle.....	HPS-H58
5.8mm DoubleLatch Hip Cannula Straight.....	DLH582
5.8mm DoubleLatch Hip Cannula Fenestrated.....	DLH583

QuickLatch® Bridge Systems for 4mm Arthroscope

Single Stopcock Bridge	QL6111
Double Stopcock Bridge	QL6112
Pressure Sensing Bridge Adapter.....	QL6210
Pressure Sensing Bridge Adapter for Extended Length Cannulas.....	QL6210XL
Scope Cleaning Kit.....	T0001

Replacement Parts

Blunt Obturator.....	QL6101
Conical Obturator.....	QL6102
Sharp Trocar.....	QL6103
Cannulated Obturator (Compatible with CONMED 's 2220, T4906, and T4906-11 Switching Sticks).....	QL6104
Sheath Body O-ring (Replacement), Qty. 2.....	T4904
Stopcock O-ring (Replacement), Qty. 4.....	T4908
Stopcock Locking Nut.....	T4905
Single Stopcock Assembly.....	T5801
Double Stopcock Assembly.....	T5802
Pressure Sensing Single Stopcock Assembly.....	T5101
Pressure Sensing Double Stopcock Assembly.....	T5102
Pressure Sensing Outer Tip Assembly.....	QL6201
Pressure Sensing Stopcock O-ring (replacement).....	T5104
Pressure Sensing O-ring, Outer Tip Assembly, Qty. 2.....	QL6205
Pressure Sensing 5.9mm Sheath Body.....	QL6230

All products may not be available in all markets.

Bridge Cannulas

	Cat. No.
4.6mm Stainless Steel Cannula	OC4601
4.6mm Stainless Steel 30°/70° Cannula (for use with CONMED 's T-Series 4mm Arthroscopes)	OC4606
4.6mm Stainless Steel Fenestrated Cannula	OC4607
4.6mm Trocar	OC4603
4.6mm Conical Obturator	OC4604
4.6mm Cannulated Obturator (Compatible with CONMED 's 2220, T4906, and T4906-11 Switching Sticks)	OC4605
5.8mm Stainless Steel Cannula	OC5801
5.8mm Stainless Steel 30°/70° Cannula (for use with CONMED 's T-Series 4mm Arthroscopes)	OC5806
5.8mm Trocar	OC5803
5.8mm Conical Obturator	OC5804
5.8mm Cannulated Obturator (Compatible with CONMED 's 2220, T4906, and T4906-11 Switching Sticks)	OC5805
5.8mm Extended Length Stainless Steel Cannula (compatible with QuickLatch® 4mm Arthroscopes and T4911, T4912, or QL6210LX Bridge Adapters)	OC5801XL
5.8mm Extended Length Conical Obturator	OC5804XL
7.6mm Stainless Steel Cannula	OC7601
7.6mm Stainless Steel 30°/70° Cannula (for use with CONMED 's T-Series 4mm Arthroscopes)	OC7606
7.6mm Trocar	OC7603
7.6mm Conical Obturator	OC7604
7.6mm Cannulated Obturator (compatible with CONMED 's 2220, T4906, and T4906-11 Switching Sticks)	OC7605
Silicone Cannula Seal (latex free), 1per Package	7557
Infusion Adapter	7554

Pressure Sensing Cannula System

For use with the 87k® Fluid Control System and Apex Pressure Sensing tubing sets. This system allows for true intra-articular pressure measurement.

- » Dual cannulation to provide separate fluid inflow and pressure measurement
- » Outer cannula is removable for patient entry and cleaning
- » Fenestrations

For a complete set-order: Inner Cannula, Outer Cannula, Trocar, Obturator, and Inflow Adapter.

5.1mm O.D.	Inner Cannula	Outer Cannula	Trocar	Obturator	Inflow Adapter
3.5" (89mm) length	83255	83256	83257	83258	83234
5.0" (127mm) length	83225	83226	83227	83228	83234

Cat. No.

Inflow Adapter for 5.1mm O.D. Cannula System (Converts to Luer).....83234

6.3mm O.D.	Inner Cannula	Outer Cannula	Trocar	Obturator	Inflow Adapter
3.5" (89mm) length	83244	83243	83241	83242	83235
5.0" (127mm) length	83264	83263	83261	83262	83235



Stainless Steel Cannula

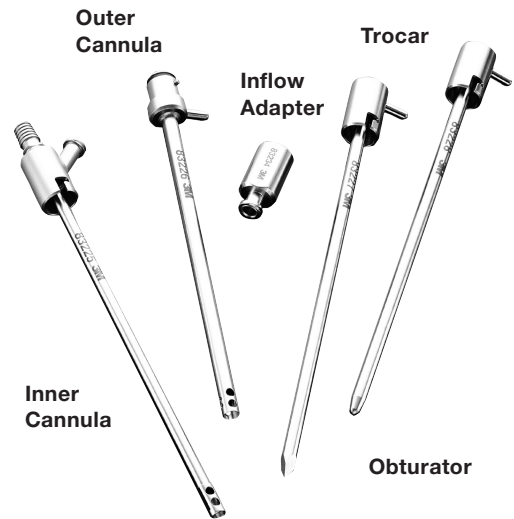

**Inner
Cannula**

**Outer
Cannula**

**Inflow
Adapter**

Trocar

Obturator

All products may not be available in all markets.

Cat. No.

Replacement O-ring for Outer Cannulas	78807039595
Replacement Parts for Quick-Connect® Sheath Sets (T5830, T5831, T5832, T5833, T5870, T5871, T5872, and T5873)	

**Quick-Connect sheaths are compatible with CONMED's
non-QuickLatch® 4mm Arthroscopes.**

5.8mm Fenestrated 30° Sheath Body	T5834
5.8mm Non-Fenestrated 30° Sheath Body	T5835
5.8mm Fenestrated 30°/70° Sheath Body	T5874
5.8mm Non-Fenestrated 30°/70° Sheath Body	T5875
Single Stopcock Bridge	T5811
Double Stopcock Bridge	T5812
Blunt Obturator	T5803
Conical Obturator	T5804
Sharp Trocar	T5805
Single Stopcock Assembly	T5801
Double Stopcock Assembly	T5802
Stopcock Lock	T5814
Replacement O-ring for Sheath	T4908
Replacement Stopcock Nut	T4905

Sterilization Trays

CONMED offers an assortment of plastic trays to hold endoscopes. Endoscopes are cradled in protective silicone to prevent possible damage during handling, sterilization or storage.

	Cat. No.
Autoclavable Arthroscope Tray (holds 2 scopes) Dimensions 3.2" w x 1.4" h x 12" d.....	C3106
Autoclavable Laparoscope Tray (holds 2 scopes) Dimensions 3.2" w x 1.4" h x 17" d.....	C3107

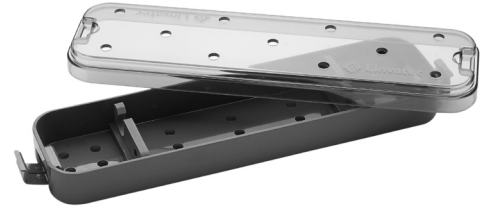

C3106

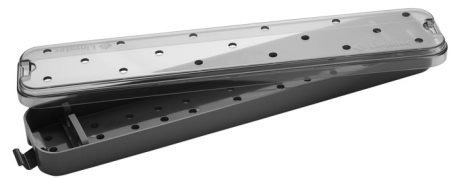

C3107

All products may not be available in all markets.



Arthroscopy Product Catalog

525 French Road, Utica, NY 13502

Customer Service: 800-237-0169

International Sales: +1-727-392-6464

Fax: 727-397-4540

Website: CONMED.com

Email: info@mail.CONMED.com